

KARMA[®]
POWERLED LIGHTING



OUTDOOR
INDOOR



Catalog

2017

MADE IN ITALY

Sostenibilità, innovazione, qualità. Sono questi i principali punti che caratterizzano la linea di prodotti Karma.

Un vastissimo assortimento di prodotti garantirà la migliore soluzione per la luminosità della vostra abitazione, dall'illuminazione esterna a quella interna, passando per un'ampia gamma di articoli, dalle plafoniere a tutti gli incassi con Power Led, a luce diffusa o a Cob di potenza con parabola. L'azienda è situata a Gardigiano di Scorzè, in provincia di Venezia. Discendenti diretti della migliore tradizione luministica veneziana, gli esperti di Karmaled saranno molto orgogliosi di mostrarvi il valore emozionale e culturale della luce, attraverso una linea di prodotti figlia di un'intensa ricerca ed un attento lavoro. Una luce che saprà dar valore ai vostri ambienti.

Sustainability, innovation, quality. These are the main aspects that distinguish Karma's product line.

A huge assortment of products will guarantee you the best solution for your home lighting, from inside to outside, from light bulbs to ceiling lights and all the recess light solution with PowerLed, diffuse light and Power Cob spotlight.

The company is located in Gardigiano di Scorzè, near Venice. Direct descendants of the best Venetian lighting tradition, Karmaled's experts are very proud to show you the emotional and cultural value of light through a product line born from an intense research and a careful work. A light that bring value to your spaces.



Prodotti custom

La luce è un elemento fondamentale delle nostre vite e per questo ha bisogno della giusta attenzione. Per tali ragioni, siamo orgogliosi di offrire la possibilità di personalizzare i prodotti, perchè siano utilizzati in maniera ottimale in qualsiasi tipologia di ambiente. Un servizio di Customer Service, vi consiglierà come adattare al meglio i prodotti Karma con i vostri spazi e le vostre esigenze.

Custom products

Light is an essential element of our life and it deserves the right attention. For these reasons, we are proud to offer the possibility to customize our products, so they can be used in the best way for every kind of location. Our Customer Service will suggest you how to best adapt Karma products to your spaces.



Ricerca e progettazione

Karma si pone l'obiettivo di offrire le migliori soluzioni in campo illuminotecnico. Grazie ad un costante lavoro di ricerca, i nostri esperti sapranno offrire al mercato le risposte più adatte in termini di innovazione e performance tecnologica.

La luce è un aspetto integrante delle nostre vite, oltre ad essere un elemento fondamentale per dar valore e forma alle nostre abitazioni. Karmaled tiene in considerazione questi aspetti, integrandoli con un sapiente lavoro di tecnica e creatività. Per questi motivi, affidarsi ai nostri esperti è la soluzione migliore.

Research and design

Karma's target is to offer the best solution for lighting. Thanks to a constant research, our experts can always suggest you the right solutions in terms of innovation and technical performance.

Light is an essential element of our life and it is an indispensable aspect to model and give value to our buildings. Karmaled considers these aspects and integrates them with a wise work of technique and creativity. For these reasons, to rely on our experts is the best solution for you.

Assistenza del laboratorio tecnico

Per qualsiasi chiarimento, Karma si avvale di un valido e completo servizio di assistenza condotto da una direzione tecnica, in grado di dare quotidianamente risposte precise ed affidabili. Completamente al servizio dei clienti, i nostri esperti sapranno fornire qualsiasi genere di supporto per farvi godere pienamente dei nostri prodotti. Le principali attività della nostra azienda: Progettazione - Laboratorio - Customer Service - Test EMC Pre-Compliance - Test climatici - Rilevazioni Fotometriche, permettono di poter realizzare prodotti personalizzabili, per dare risposte sempre più elastiche e concrete ad un mercato in continua evoluzione.

Il supporto alla vendita è il valore aggiunto della nostra azienda. Uffici commerciali rispondono costantemente ai clienti per consigliare il prodotto più idoneo. Un'attenzione continua verso le richieste esterne, che dal supporto alla vendita, al servizio di assistenza, passando per il servizio di personalizzazione, segue in ogni passo il cliente, supportandolo in ogni genere di esigenza. Il reparto Lighting Design rappresenterà il futuro dell'azienda dove giovani dinamici daranno vita a progetti illuminotecnici.

Technical support

For any clarification, Karma has a valid and complete technical support that can help you with correct and reliable answers. Completely at the service of our customers, our experts will be able to give you help in any circumstance, to enjoy our products at best. Main activities of our company are: Design - Laboratory - Customer Service - Pre-Compliance EMC Test - Climatic test - Photometric analysis.

These permit us to achieve customizable products, to full satisfy a market that is continuously evolving.

Sales support is the added valued for our company.

Our commercial offices constantly answer customers to suggest the best product for them. A continuous attention to external requests follows the customer in any step, leading him from sales to customization, helping to satisfy any need. The Lighting Design department will represent the future of our company, where a young and dynamic team will bring life to lighting projects.



INDICE

Taurus

pag. 8 - 29



TA35
pag. 10



TA31
pag. 14



TA31
pag. 16



TA25
pag. 20



TA25
pag. 22



TA25
pag. 24



TA15
pag. 28

Aquarius

pag. 32 - 39



AQ35
pag. 32



AQ25N
pag. 34



AQ26N
pag. 36



AQ24N
pag. 38

Phoenix

pag. 42 - 51



PH01S
pag. 44



PH02S
pag. 45



PH03S PH11S
pag. 46



PH04S PH12S
pag. 47



PH05R PH11R
pag. 48



PH06R PH12R
pag. 49



PH03C PH11C
pag. 50



PH05T PH11T
pag. 51

Orion

pag. 54 - 57



OR25
pag. 54



OR26
pag. 56

Crux

pag. 60 - 61



CR22N
pag. 60

Dorado

pag. 64 - 69



DO00N
pag. 64



DO05N
pag. 66



DO06N
pag. 68

Grus

pag. 72 - 79



GR210
pag. 74



GR210
pag. 76



GR210
pag. 78

Lira

pag. 82 - 87



LI11N
pag. 84



LI13N
pag. 86

Pegasus

pag. 90 - 93



PE46
pag. 90

PE47
pag. 90

PE48
pag. 91

TRACK
pag. 92

Antares

pag. 96 - 103



AN02N
pag. 96



AN12N
pag. 98



AN14N
pag. 100



AN35N
pag. 101



AN38N
pag. 102

Scorpius

pag. 106 - 112



SC02
pag. 106



SC16
pag. 108



SC17
pag. 109



SC18
pag. 110



SC19
pag. 111



SC20
pag. 112

Sagittarius

pag. 113



SG01
pag. 113

Delphinus

pag. 116 - 119



DE02
pag. 116



DE12
pag. 118

Draco

pag. 122 - 123



DR01-15
pag. 122

Pannelli

pag. 126 - 131



PAN60
pag. 126



PAN69UGR
pag. 128



PAN12
pag. 130

Strip

pag. 134 - 147



STRISCE DO
pag. 134 - 147

Profili

pag. 152 - 193



PROF1
pag. 152



PROF2
pag. 154



PROF3
pag. 156



PROF4
pag. 158



PROF43N
pag. 160



PROF47N
pag. 162



PROF54N
pag. 164



PROF61N
pag. 166



PROF62N
pag. 168



PROF63N
pag. 170



PROF72N
pag. 172



PROF73N
pag. 174



PROF48N
pag. 176



PROF80N
pag. 178



PROF81N
pag. 180



PROF82N
pag. 182



PROF83N
pag. 184



PROF86N
pag. 186



PROF87N
pag. 188



PROF88N
pag. 190



PROF89N
pag. 192

Accessori

pag. 196 - 223

ALIMENTATORI
DRIVERS
pag. 196

SENSORI
SENSORS
pag. 216

CENTRALINE
CONTROLLERS
pag. 218

INDICE DETTAGLIATO
DETAILED INDEX pag. 224

GRAFICO APERTURA LENTI
LENSES WIDTH CHART pag. 226

GUIDA ALLA CONSULTAZIONE
CONSULTATION GUIDE pag. 227





Taurus

Apparecchi a LED da incasso per esterni,
con flange intercambiabili
*LED recessed devices for outdoor,
with interchangeable flanges*



Karma presenta il brevetto 2017 della nuova serie Taurus

Ecco una grande novità nel mondo dei corpi illuminanti: finalmente viene data una risposta adeguata al pubblico che si rivolge al mercato dell'illuminazione a LED per i fari da incasso esterno e che ricerca prodotti puliti, eleganti e ben rifiniti, senza viti in vista. Grazie alla grande esperienza produttiva dei tecnici presenti in azienda, si è potuto creare un sistema dinamico ed innovativo: un motore estremamente compatto ed affidabile sia come prestazioni che come tenuta all'acqua. Ma la novità in assoluto è rappresentata dagli accessori intercambiabili che permettono la scelta e la modifica del prodotto con tempi rapidi.

Grazie alla sua semplicità, il prodotto è facilmente riparabile e modificabile nell'aspetto estetico; un esempio ne è il modello senza viti che incontra le richieste sempre più frequenti dei progettisti. Inoltre l'alimentazione a 24Vdc con due fili, di serie su tutta la gamma Taurus permette la dimmerazione con tecnologia PWM.

Taurus 2017, grazie a Karma, aprirà una nuova frontiera nei prodotti da esterno MADE IN ITALY.

La gamma

La serie Taurus è stata creata con l'obiettivo di poter dare una risposta semplice ma completa a tutta la clientela. La gamma si sviluppa in 4 prodotti: un MONOLED di potenza 3W diam. 60 mm, un MONOLED di nuova tecnologia con potenza 9W diam. 80 mm, un trittico da 9W diam. 130 mm e infine un 7 LED da 21W diam. 170 mm.

Per ogni prodotto c'è la possibilità di scegliere la tonalità di luce, che può essere 3000°K, 4000°K, 6000°K, BLU e RGB e l'angolo della lente, secondo l'applicazione e l'effetto che si vuole ottenere. A livello estetico, ogni prodotto viene abbinato ad una serie specifica di flange, tonde o quadrate, con o senza viti, filo pavimento o ad emissione laterale, funghi o paletti in altezza 30 cm.

Karma presents the patent 2017 of new Taurus line

Here is a great novelty in the world of lighting fixtures: at last an appropriate response is given to people which is targeting the LED lighting market for outdoor recessed headlights and looking for clean, stylish and well finished products with no screws at view. Thanks to the great production experience of the technicians in the company, it was possible to create a dynamic and innovative system: an extremely compact and reliable engine both as a performance and waterproof. But the absolute novelty is represented by interchangeable accessories that allow you to choose and modify your product quickly.

Due to its simplicity, the product is easily repairable and editable in aesthetic appearance; an example is the sculptural model that meets the ever-increasing demands of designers. In addition, the system of 24Vdc power supply with two wires, standard on the entire Taurus range, allows dimmering with PWM technology. Taurus 2017, thanks to Karma company, will open a new frontier for outdoor MADE IN ITALY products.

The range

The Taurus Series is created with the aim of giving a simple but complete answer to all the customers. The range is developed in 4 products: a 3W power MONOLED diam. 60 mm, a 9W power new technological MONOLED diam. 80 mm, a 3-LED module with 9W power and diam. 130 mm and a 7-LED module with 21W diam. 170 mm.

For each product there is a choice of light shade, which can be 3000°K, 4000°K, 6000°K, BLUE and RGB and the angle of the lens, depending on the application and the effect you desire. At aesthetic level, each product is matched to a specific series of flanges, round or square, with or without screws, flooring or side emitter installation, side emitter mushrooms or column light in height 30 cm.

Alimentazione innovativa a 24Vdc dimmerabile su 2 fili



Innovative power at 24Vdc 2 cables dimmable



TA35

Il prodotto TA35 è il più piccolo della gamma, con il suo frontale da 63 mm alloggia un MONOLED di potenza 3W.

Come per ogni prodotto c'è la possibilità di scegliere la tonalità di luce, che può essere 3000°K, 4000°K, 6000°K, BLU e RGB e l'angolo della lente, secondo l'applicazione e l'effetto che si vuole ottenere.

A livello estetico, TA35 viene abbinato ad una serie specifica di flange, tonda, quadra e filo pavimento, tutte senza viti in vista.

The TA35 product is the smallest one in the range, with its frontal 63 mm diameter and 3W power MONOLED.

As for each product there is a choice of light shade, which can be 3000°K, 4000°K, 6000°K, BLUE and RGB and the angle of the lens, depending on the application and the effect you desire.

At aesthetic level, TA35 is matched to a specific series of flanges, square and flooring installation, all three flanges are without screws at sight.

TA35



Motore base compatto, calibrato e proporzionato per 1 LED High Power o RGB, per applicazioni esterne, interne con alto tasso di umidità.

Dispositivo che, data la sua compattezza, permette di essere utilizzato in un numero considerevole di applicazioni, per illuminare pareti e percorsi.

Grazie al grado di IP dichiarato, può essere utilizzato in ambienti con elevato tasso di umidità, quali docce o saune, nonché in bocche di lupo. Sono previste due controcasse per l'installazione in gettata, oltre a quella standard è prevista una controcassa speciale per installazione filo pavimento. La controcassa non è in dotazione con il faro.

Sono disponibili vari angoli di emissione e tonalità della luce.

Compact, calibrated and proportionate fixture for 1 piece of High Power or RGB LED, for outdoor or indoor applications, also in places with high humidity.

Due to its compactness, the item TA35 allows it to be used in a lot of applications, to illuminate walls and paths.

As well as its IP rating, it can be used in high humidity environments such as showers or saunas as well as in basement window wells.

Karma company offers you two different plastic recessed boxes for installation, in addition to the standard one, there is special housing for recessed to the flooring installation. The back cover is not supplied with the fixture, you have to request it separately.

Various angles of emission and light shades are available.

Per la versione a 24Vdc, il prodotto viene corredato di un driver sul cavo di alimentazione.
For the 24Vdc version, the product is equipped with a driver on the input wire.

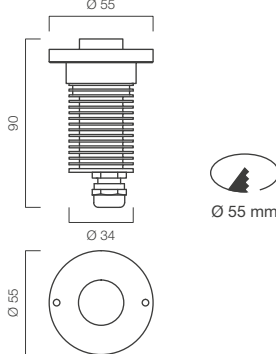

Code TA35RFL
Flangia tonda filo pavimento
Round recessed flooring installation flange

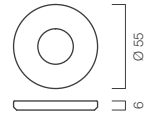

Code TA35SL
Flangia quadra senza fori
Square flange without holes

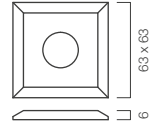

Code TA35RL
Flangia tonda senza fori
Round flange without holes

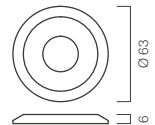

Led color

1 = 3000°K (247 lumen)

2 = 6000°K (283 lumen)

3 = Blu / Blue

7 = RGB

9 = 4000°K (266 lumen)

Power supply

1 = 350mA

5 = 24Vdc

Code	TA35
Power	3W (1 LED HP SMD)
Led color	1-2-3-9
Spot	A-B-D-G
Power supply	5

Code	TA35
Power	3W (1 LED RGB)
Led color	7
Spot	A-B-D-G
Power supply	1

Spot

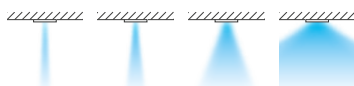

G = 8° **A** = 15° **B** = 45° **D** = 120°

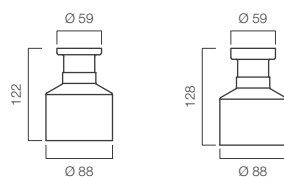

Code TA351

Controcassa

in plastica

Plastic recessed box

Code TA352

Controcassa in plastica

filo pavimento

Plastic recessed box flooring installation

Finitura flangia / Flange finishing



Acciaio inox AISI316L
Stainless steel AISI316L

Esempio codici ordine / Example order codes

Codice flangia / Flange code Codice motore / Engine code Codice controcassa / Box code

TA35RFL + **TA353W2D5** + **TA352**

Diagramma a cono rilevato con LED HP SMD, lente 45°, bianco caldo.

Cone diagram measured with warm white, HP SMD LED, lens 45°.

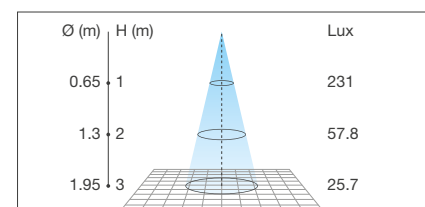



Codice accessori elettrici / *Electrical accessories code*

TA35 3W

Power supply IP67

APP009.24	1 - 2	ALP120.24	1 - 34
ALP015.24	1 - 4	ALP150.24	1 - 40
ALP030.24	1 - 8	ALP200.24	1 - 55
ALP060.24	1 - 18		

Dimmer Controller IP20

AL240P	1 - 68
AL288D/P	1 - 80
CTR112DIM	1 - 80

RGB Controller IP20

CTR031	DRVRGB.IP
CTR203C1W	

RGB Driver IP67

Karma presenta il brevetto 2017 della nuova serie Taurus

Ecco una grande novità nel mondo dei corpi illuminanti: finalmente viene data una risposta adeguata al pubblico che si rivolge al mercato dell'illuminazione a LED per i fari da incasso esterno e che ricerca prodotti puliti, eleganti e ben rifiniti, senza viti in vista. Grazie alla grande esperienza produttiva dei tecnici presenti in azienda, si è potuto creare un sistema dinamico ed innovativo: un motore estremamente compatto ed affidabile sia come prestazioni che come tenuta all'acqua. Ma la novità in assoluto è rappresentata dagli accessori intercambiabili che permettono la scelta e la modifica del prodotto con tempi rapidi.

Grazie alla sua semplicità, il prodotto è facilmente riparabile e modificabile nell'aspetto estetico; un esempio ne è il modello senza viti che incontra le richieste sempre più frequenti dei progettisti. Inoltre l'alimentazione a 24Vdc con due fili, di serie su tutta la gamma Taurus permette la dimmerazione con tecnologia PWM.

Taurus 2017, grazie a Karma, aprirà una nuova frontiera nei prodotti da esterno MADE IN ITALY.

La gamma

La serie Taurus è stata creata con l'obiettivo di poter dare una risposta semplice ma completa a tutta la clientela. La gamma si sviluppa in 4 prodotti: un MONOLED di potenza 3W diam. 60 mm, un MONOLED di nuova tecnologia con potenza 9W diam. 80 mm, un tritico da 9W diam. 130 mm e infine un 7 LED da 21W diam. 170 mm.

Per ogni prodotto c'è la possibilità di scegliere la tonalità di luce, che può essere 3000°K, 4000°K, 6000°K, BLU e RGB e l'angolo della lente, secondo l'applicazione e l'effetto che si vuole ottenere. A livello estetico, ogni prodotto viene abbinato ad una serie specifica di flange, tonde o quadrate, con o senza viti, filo pavimento o ad emissione laterale, funghi o paletti in altezza 30 cm.

Karma presents the patent 2017 of new Taurus line

Here is a great novelty in the world of lighting fixtures: at last an appropriate response is given to people which is targeting the LED lighting market for outdoor recessed headlights and looking for clean, stylish and well finished products with no screws at view. Thanks to the great production experience of the technicians in the company, it was possible to create a dynamic and innovative system: an extremely compact and reliable engine both as a performance and waterproof. But the absolute novelty is represented by interchangeable accessories that allow you to choose and modify your product quickly.

Due to its simplicity, the product is easily repairable and editable in aesthetic appearance; an example is the sculptural model that meets the ever-increasing demands of designers. In addition, the system of 24Vdc power supply with two wires, standard on the entire Taurus range, allows dimmering with PWM technology. Taurus 2017, thanks to Karma company, will open a new frontier for outdoor MADE IN ITALY products.

The range

The Taurus Series is created with the aim of giving a simple but complete answer to all the customers. The range is developed in 4 products: a 3W power MONOLED diam. 60 mm, a 9W power new technological MONOLED diam. 80 mm, a 3-LED module with 9W power and diam. 130 mm and a 7-LED module with 21W diam. 170 mm.

For each product there is a choice of light shade, which can be 3000°K, 4000°K, 6000°K, BLUE and RGB and the angle of the lens, depending on the application and the effect you desire. At aesthetic level, each product is matched to a specific series of flanges, round or square, with or without screws, flooring or side emitter installation, side emitter mushrooms or column light in height 30 cm.

Alimentazione innovativa a 24Vdc dimmerabile su 2 fili



Innovative power at 24Vdc 2 cables dimmable

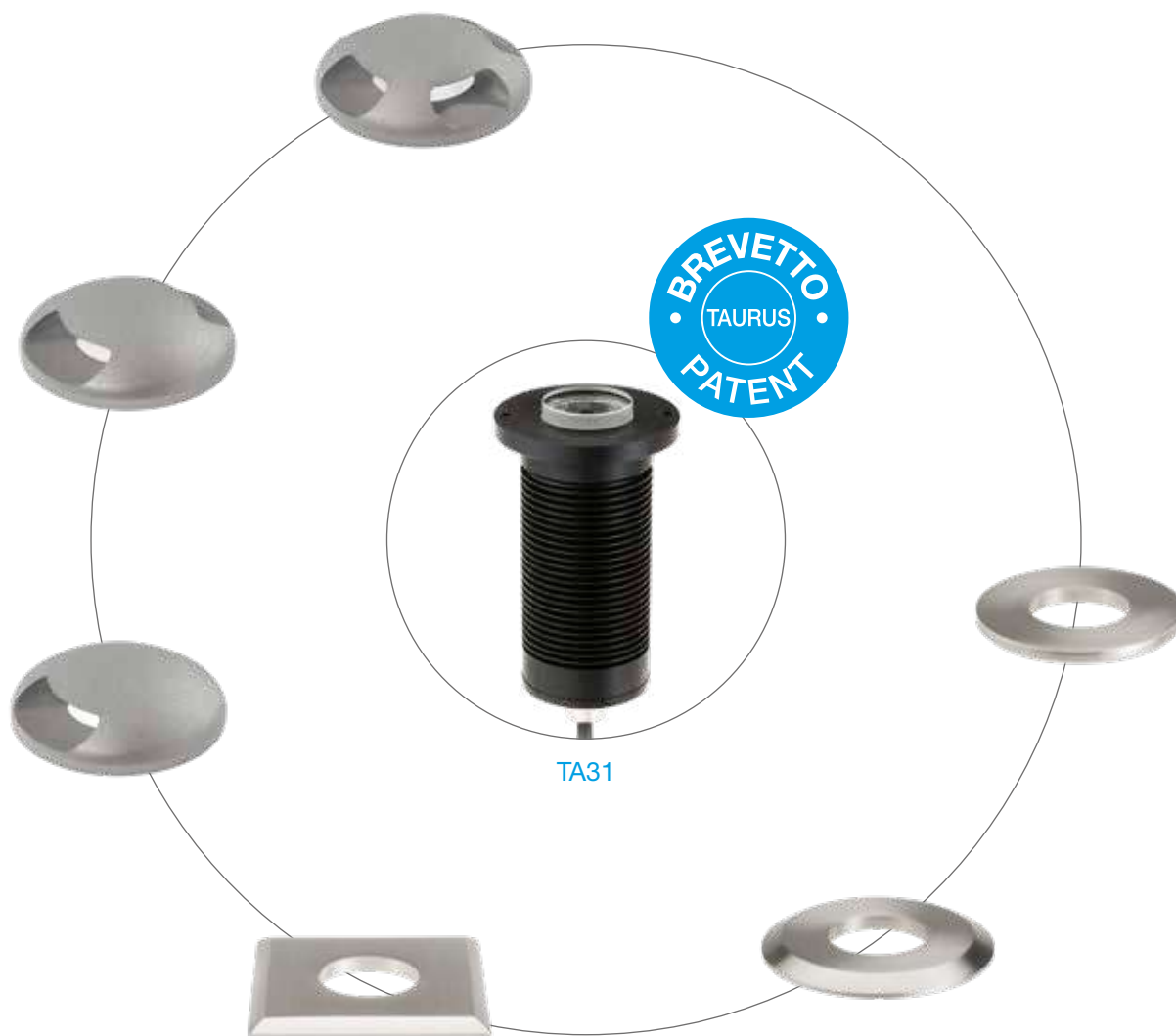

TA31 è un prodotto di dimensioni compatte, con il frontale da 80 mm, con MONOLED di nuova tecnologia di potenza 9W.

Come per ogni prodotto c'è la possibilità di scegliere la tonalità di luce, che può essere 3000°K e 4000°K, l'angolo della lente, secondo l'applicazione e l'effetto che si vuole ottenere.

A livello estetico, TA31 viene abbinato ad una serie specifica di flange: tonda, quadra, filo pavimento, fungo monoemissione, biemissione o a 4 emissioni. Tutte le flange sono senza viti in vista.

The TA31 item is a compact product (with diameter of frontal of 80 mm), with a 9W power new technology MONOLED.

As for each product there is a choice of light shade, which can be 3000°K and 4000°K, the angle of the lens, depending on the application and the effect you desire.

At aesthetic level, TA31 is matched to a specific series of flange: round, square, flooring installation, mono directional light, bi-directional light or 4 directional light. All flanges are without screws in sight.

TA31

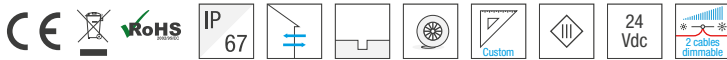

Motore base compatto ad elevata potenza, calibrato e proporzionato per 1 LED High Intensity per applicazioni esterne, interne con alto tasso di umidità.

Dispositivo che, data la sua compattezza, permette di essere utilizzato in un numero considerevole di applicazioni, per illuminare pareti e percorsi.

Grazie al grado di IP dichiarato, può essere utilizzato in ambienti con elevato tasso di umidità, quali docce o saune, nonché in bocche di lupo. Sono previste due controcasse per l'installazione in gettata, oltre a quella standard è prevista una controcassa speciale per installazione filo pavimento. La controcassa non è in dotazione con il faro.

Sono disponibili vari angoli di emissione e tonalità della luce.

Compact, high performance, calibrated, proportionate fixture for 1 piece of High Intensity LED, for outdoor or indoor applications, also in places with high humidity.

Due to its compactness, the item TA31 allows it to be used in a lot of applications, to illuminate walls and paths.

As well as its IP rating, it can be used in high humidity environments such as showers or saunas as well as in basement window wells. Karma company offers you two different plastic recessed boxes for installation, in addition to the standard one, there is special housing for recessed to the flooring installation. The back cover is not supplied with the fixture, you have to request it separately. Various angles of emission and light shades are available.

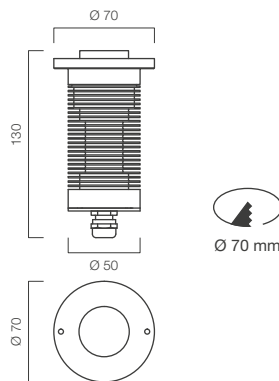

Spot

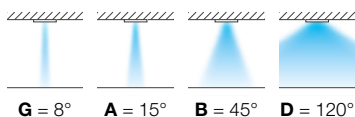

Finitura flangia / Flange finishing



Acciaio inox AISI316L
Stainless steel AISI316L

Esempio codici ordine / Example order codes

Codice flangia / Flange code

Codice motore / Engine code

Codice controcassa / Box code

TA31SL

+ TA319W1A5

+ TA311

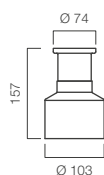

Code TA311
Controcassa
in plastica
Plastic recessed
box

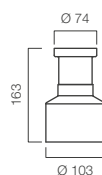

Code TA312
Controcassa in plastica
filo pavimento
Plastic recessed box
flooring installation

Code TA31RFL
Flangia tonda filo pavimento
Round recessed flooring
installation flange



Code TA31SL
Flangia quadra senza fori
Square flange without holes

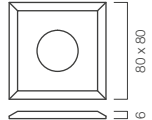

Code TA31RL
Flangia tonda senza fori
Round flange without holes



Led color

1 = 3000°K (964 lumen)

9 = 4000°K (1000 lumen)

Power supply

5 = 24Vdc

Code	TA31
Power	9W (1 LED HI SMD)
Led color	1-9
Spot	A-B-D-G
Power supply	5

Diagramma a coni rilevato con LED HI SMD, lente 45°, bianco naturale.

Cone diagram measured with natural white, HI SMD LED, lens 45°.

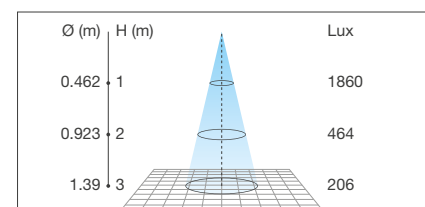



Codice accessori elettrici / *Electrical accessories code*

TA31 9W

Power supply IP67

ALP015.24	1	ALP120.24	1 - 12
ALP030.24	1 - 3	ALP150.24	1 - 15
ALP060.24	1 - 6	ALP200.24	1 - 21

Dimmer Controller IP20

AL240P	1 - 22
AL288D/P	1 - 27
CTR112DIM	1 - 27

TA31



Motore base compatto ad elevata potenza, calibrato e proporzionato per 1 LED High Intensity per applicazioni esterne, interne con alto tasso di umidità.

Dispositivo che, data la sua compattezza, permette di essere utilizzato in un numero considerevole di applicazioni, per illuminare pareti e percorsi.

Grazie al grado di IP dichiarato, può essere utilizzato in ambienti con elevato tasso di umidità, quali docce o saune, nonché in bocche di lupo. Sono previste due controcasse per l'installazione in gettata, oltre a quella standard è prevista una controcassa speciale per installazione filo pavimento. La controcassa non è in dotazione con il faro.

Sono disponibili vari angoli di emissione e tonalità della luce.

Compact, high performance, calibrated, proportionate fixture for 1 piece of High Intensity LED, for outdoor or indoor applications, also in places with high humidity.

Due to its compactness, the item TA31 allows it to be used in a lot of applications, to illuminate walls and paths.

As well as its IP rating, it can be used in high humidity environments such as showers or saunas as well as in basement window wells.

Karma company offers you two different plastic recessed boxes for installation, in addition to the standard one, there is special housing for recessed to the flooring installation. The back cover is not supplied with the fixture, you have to request it separately. Various angles of emission and light shades are available.

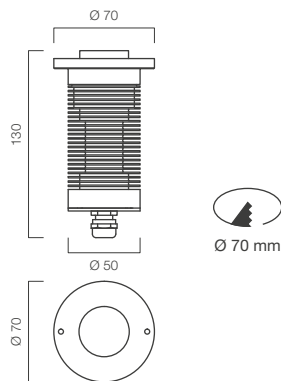

Spot



E = 10°

Finitura flangia / Flange finishing



Alluminio anodizzato
Anodized Aluminum

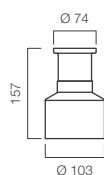

Code TA311
Controcassa in plastica
Plastic recessed box

Esempio codici ordine / Example order codes

Codice flangia / Flange code

Codice motore / Engine code

Codice controcassa / Box code

TA31M2P

+ TA319W9E5

+ TA311

Code TA31M4P
Flangia a fungo 4 emissioni
4 way light mushroom flange

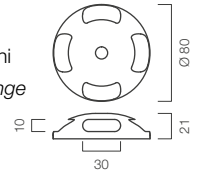

Code TA31M2P
Flangia a fungo biemissione
Double way light mushroom flange

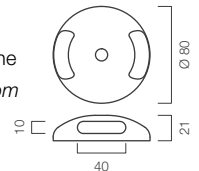

Code TA31M1P
Flangia a fungo monoemissione
Single way light mushroom flange

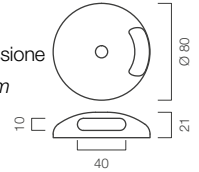

Led color

1 = 3000°K (964 lumen)

9 = 4000°K (1000 lumen)

Power supply

5 = 24Vdc

Code **TA31**

Power **9W** (1 LED HI SMD)

Led color **1-9**

Spot **E**

Power supply **5**

Diagramma a cono rilevato con LED HI SMD, bianco naturale, flangia M1P.

Cone diagram measured with natural white, HI SMD LED, M1P flange.

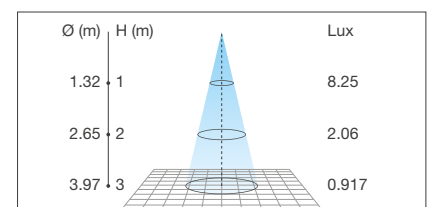



Codice accessori elettrici / *Electrical accessories code*

TA31 9W

Power supply IP67

ALP015.24	1	ALP120.24	1 - 12
ALP030.24	1 - 3	ALP150.24	1 - 15
ALP060.24	1 - 6	ALP200.24	1 - 21

Dimmer Controller IP20

AL240P	1 - 22
AL288D/P	1 - 27
CTR112DIM	1 - 27

Karma presenta il brevetto 2017 della nuova serie Taurus

Ecco una grande novità nel mondo dei corpi illuminanti: finalmente viene data una risposta adeguata al pubblico che si rivolge al mercato dell'illuminazione a LED per i fari da incasso esterno e che ricerca prodotti puliti, eleganti e ben rifiniti, senza viti in vista. Grazie alla grande esperienza produttiva dei tecnici presenti in azienda, si è potuto creare un sistema dinamico ed innovativo: un motore estremamente compatto ed affidabile sia come prestazioni che come tenuta all'acqua. Ma la novità in assoluto è rappresentata dagli accessori intercambiabili che permettono la scelta e la modifica del prodotto con tempi rapidi.

Grazie alla sua semplicità, il prodotto è facilmente riparabile e modificabile nell'aspetto estetico; un esempio ne è il modello senza viti che incontra le richieste sempre più frequenti dei progettisti. Inoltre l'alimentazione a 24Vdc con due fili, di serie su tutta la gamma Taurus permette la dimmerazione con tecnologia PWM.

Taurus 2017, grazie a Karma, aprirà una nuova frontiera nei prodotti da esterno MADE IN ITALY.

La gamma

La serie Taurus è stata creata con l'obiettivo di poter dare una risposta semplice ma completa a tutta la clientela. La gamma si sviluppa in 4 prodotti: un MONOLED di potenza 3W diam. 60 mm, un MONOLED di nuova tecnologia con potenza 9W diam. 80 mm, un tritico da 9W diam. 130 mm e infine un 7 LED da 21W diam. 170 mm.

Per ogni prodotto c'è la possibilità di scegliere la tonalità di luce, che può essere 3000°K, 4000°K, 6000°K, BLU e RGB e l'angolo della lente, secondo l'applicazione e l'effetto che si vuole ottenere. A livello estetico, ogni prodotto viene abbinato ad una serie specifica di flange, tonde o quadrate, con o senza viti, filo pavimento o ad emissione laterale, funghi o paletti in altezza 30 cm.

Karma presents the patent 2017 of new Taurus line

Here is a great novelty in the world of lighting fixtures: at last an appropriate response is given to people which is targeting the LED lighting market for outdoor recessed headlights and looking for clean, stylish and well finished products with no screws at view. Thanks to the great production experience of the technicians in the company, it was possible to create a dynamic and innovative system: an extremely compact and reliable engine both as a performance and waterproof. But the absolute novelty is represented by interchangeable accessories that allow you to choose and modify your product quickly.

Due to its simplicity, the product is easily repairable and editable in aesthetic appearance; an example is the sculptural model that meets the ever-increasing demands of designers. In addition, the system of 24Vdc power supply with two wires, standard on the entire Taurus range, allows dimmering with PWM technology. Taurus 2017, thanks to Karma company, will open a new frontier for outdoor MADE IN ITALY products.

The range

The Taurus Series is created with the aim of giving a simple but complete answer to all the customers. The range is developed in 4 products: a 3W power MONOLED diam. 60 mm, a 9W power new technological MONOLED diam. 80 mm, a 3-LED module with 9W power and diam. 130 mm and a 7-LED module with 21W diam. 170 mm.

For each product there is a choice of light shade, which can be 3000°K, 4000°K, 6000°K, BLUE and RGB and the angle of the lens, depending on the application and the effect you desire. At aesthetic level, each product is matched to a specific series of flanges, round or square, with or without screws, flooring or side emitter installation, side emitter mushrooms or column light in height 30 cm.

Alimentazione innovativa a 24Vdc dimmerabile su 2 fili



Innovative power at 24Vdc 2 cables dimmable



TA25 è il prodotto di più completo a livello di flange abbinato: di dimensioni compatte con frontale diametro 130 mm, con trittico da 9W.

Come per ogni prodotto c'è la possibilità di scegliere la tonalità di luce, che può essere 3000°K, 4000°K, 6000°K, BLU e RGB e l'angolo della lente, secondo l'applicazione e l'effetto che si vuole ottenere.

A livello estetico, TA25 viene abbinato ad una serie specifica di flange, tonde o quadrate, con o senza viti, filo pavimento o ad emissione laterale, funghi o paletti in altezza 30 cm.

The TA25 item is the most complete product with a lot of combined matched: compact size with frontal in diameter 110 mm, with a 3-LED module with 9W power. As for each product there is a choice of light shade, which can be 3000°K, 4000°K, 6000°K, BLUE and RGB and the angle of the lens, depending on the application and the effect you desire. At aesthetic level, TA25 is matched to a specific series of flanges, round or square, with or without screws, flooring or side emitter installation, side emitter mushrooms (mono directional light, bi-directional light or 4 directional light) or column light in height 30 cm.

TA25



Motore ad elevata potenza, calibrato e proporzionato per 3 LED High Power per applicazioni esterne, interne con alto tasso di umidità. Prodotto di punta della gamma Taurus: è il prodotto con la più ampia offerta di flange. Dispositivo che, data la sua compattezza, permette di essere utilizzato in un numero considerevole di applicazioni, per illuminare pareti e percorsi. Grazie al grado di IP dichiarato, può essere utilizzato in ambienti con elevato tasso di umidità, quali docce o saune, nonché in bocche di lupo. Sono previste due controcasse per l'installazione in gettata, oltre a quella standard è prevista una controcassa speciale per installazione filo pavimento. La controcassa non è in dotazione con il faro. Sono disponibili vari angoli di emissione e tonalità della luce.

High performance fixture, calibrated and proportioned for 3 pieces of High Power LEDs for outdoor or indoor applications, also in places with high humidity.

Top sales product of Taurus series: it is the product with the widest range of flanges.

Due to its compactness, the item TA25 allows it to be used in a lot of applications, to illuminate walls and paths.

As well as its IP rating, it can be used in high humidity environments such as showers or saunas as well as in basement window wells.

Karma company offers you two different plastic recessed boxes for installation, in addition to the standard one, there is special housing for recessed to the flooring installation. The back cover is not supplied with the fixture, you have to request it separately.

Various angles of emission and light shades are available.

Spot

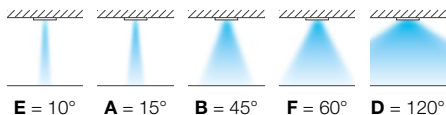

Finitura flangia / Flange finishing



Acciaio inox AISI316L
Stainless steel AISI316L

Esempio codici ordine / Example order codes

Codice flangia / Flange code Codice motore / Engine code Codice controcassa / Box code
TA25RL + **TA259W7B5** + **TA251**

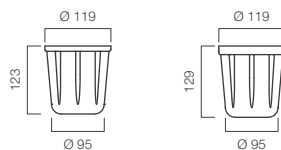
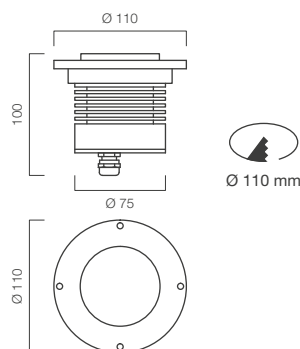

Code TA251
Controcassa
in plastica
Plastic recessed
box

Code TA252
Controcassa in plastica
filo pavimento
Plastic recessed box
flooring installation

Code TA25RFL
Flangia tonda filo pavimento
Round recessed flooring
installation flange



Code TA25SL
Flangia quadra senza fori
Square flange without holes

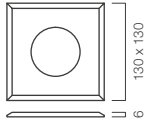

Code TA25SHL
Flangia quadra con fori
Square flange for screw fixing

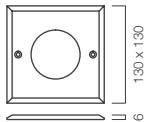

Code TA25RL
Flangia tonda senza fori
Round flange without holes

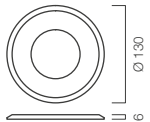

Code TA25RHL
Flangia tonda con fori
Round flange for screw fixing

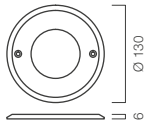

Led color

1 = 3000°K (741 lumen)
2 = 6000°K (849 lumen)
3 = Blu / Blue
7 = RGB
9 = 4000°K (798 lumen)

Power supply

5 = 24Vdc

Code	TA25
Power	8W (3 LED HP SMD)
Led color	1-2-3-9
Spot	A-B-D-E-F
Power supply	5

Code	TA25
Power	9W (3 LED RGB)
Led color	7
Spot	A-B-D
Power supply	5

Diagramma a cono rilevato con LED HP SMD, lente 45°, bianco caldo.
Cone diagram measured with warm white, HP SMD LED, lens 45°.

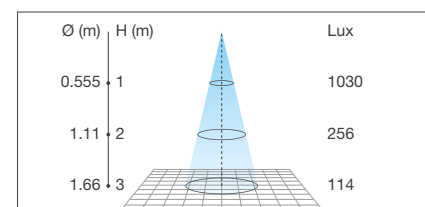



Codice accessori elettrici / *Electrical accessories code*

TA25 8W

Power supply IP67

ALP015.24	1	ALP120.24	1 - 12
ALP030.24	1 - 3	ALP150.24	1 - 15
ALP060.24	1 - 6	ALP200.24	1 - 21

Dimmer Controller IP20

AL240P	1 - 25
AL288D/P	1 - 30
CTR112DIM	1 - 30

RGB Controller IP20

CTR112RGB
CTR203CT
CTR213

TA25



Motore ad elevata potenza, calibrato e proporzionato per 3 LED High Power per applicazioni esterne, interne con alto tasso di umidità. Prodotto di punta della gamma Taurus: è il prodotto con la più ampia offerta di flange. Dispositivo che, data la sua compattezza, permette di essere utilizzato in un numero considerevole di applicazioni, per illuminare pareti e percorsi. Grazie al grado di IP dichiarato, può essere utilizzato in ambienti con elevato tasso di umidità, quali docce o saune, nonché in bocche di lupo. Sono previste due controcasse per l'installazione in gettata, oltre a quella standard è prevista una controcassa speciale per installazione filo pavimento. La controcassa non è in dotazione con il faretto. Sono disponibili vari angoli di emissione e tonalità della luce.

High performance fixture, calibrated and proportioned for 3 pieces of High Power LEDs for outdoor or indoor applications, also in places with high humidity.

Top sales product of Taurus series: it is the product with the widest range of flanges.

Due to its compactness, the item TA25 allows it to be used in a lot of applications, to illuminate walls and paths.

As well as its IP rating, it can be used in high humidity environments such as showers or saunas as well as in basement window wells.

Karma company offers you two different plastic recessed boxes for installation, in addition to the standard one, there is special housing for recessed to the flooring installation. The back cover is not supplied with the fixture, you have to request it separately. Various angles of emission and light shades are available.

Spot



E = 10°

Finitura flangia / Flange finishing



Alluminio anodizzato
Anodized Aluminum

Finitura faretto / Spotlight finishing



Acciaio inox AISI316L
Stainless steel AISI316L

Esempio codici ordine / Example order codes

Codice flangia / Flange code Codice motore / Engine code Codice controcassa / Box code
TA25M4P + **TA25H3E5** + **TA251**

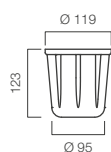
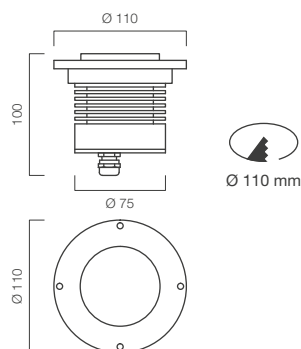

Code TA251
Controcassa in plastica
Plastic recessed box

Code TA25RSL
Faretto Side Emitter 360°
Side Emitter 360° spotlight

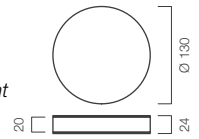

Code TA25M4P
Flangia a fungo 4 emissioni
4 way light mushroom flange

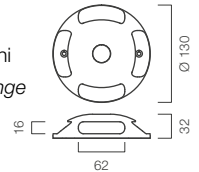

Code TA25M2P
Flangia a fungo biemissione
Double way light mushroom flange

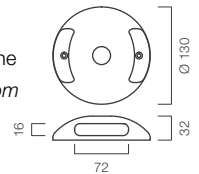

Code TA25M1P
Flangia a fungo monoemissione
Single way light mushroom flange

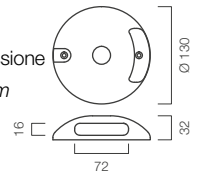

Led color

- 1** = 3000°K (741 lumen)
- 2** = 6000°K (849 lumen)
- 3** = Blu / Blue
- 9** = 4000°K (798 lumen)

Power supply

- 5** = 24Vdc

Code	TA25
Power	8W (3 LED HP SMD)
Led color	1-2-3-9
Spot	E
Power supply	5

Diagramma a cono rilevato con LED HP SMD, bianco naturale, flangia M1P.
Cone diagram measured with natural white, HP SMD LED, M1P flange.





Diagramma a cono rilevato con LED HP SMD, bianco naturale, flangia RSL.
 Cone diagram measured with natural white, HP SMD LED, RSL flange.

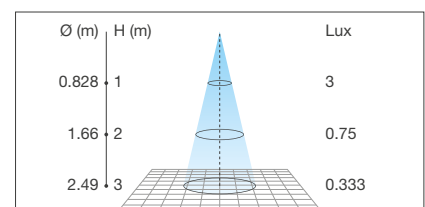
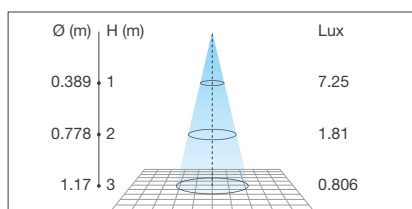

Codice accessori elettrici / Electrical accessories code

TA25 8W

Power supply IP67

ALP015.24	1
ALP030.24	1 - 3
ALP060.24	1 - 6
ALP120.24	1 - 12
ALP150.24	1 - 15
ALP200.24	1 - 21

Dimmer Controller IP20

AL240P	1 - 25
AL288D/P	1 - 30
CTR112DIM	1 - 30

RGB Controller IP20

CTR112RGB
CTR203CT
CTR213

TA25



Motore ad elevata potenza, calibrato e proporzionato per 3 LED High Power per applicazioni esterne, interne con alto tasso di umidità. Prodotto di punta della gamma Taurus: è il prodotto con la più ampia offerta di flange. Dispositivo che, data la sua compattezza, permette di essere utilizzato in un numero considerevole di applicazioni, per illuminare pareti e percorsi. Grazie al grado di IP dichiarato, può essere utilizzato in ambienti con elevato tasso di umidità, quali docce o saune, nonché in bocche di lupo. Sono previste due controcasse per l'installazione in gettata, oltre a quella standard è prevista una controcassa speciale per installazione filo pavimento. La controcassa non è in dotazione con il faro. Sono disponibili vari angoli di emissione e tonalità della luce.

High performance fixture, calibrated and proportioned for 3 pieces of High Power LEDs for outdoor or indoor applications, also in places with high humidity.

Top sales product of Taurus series: it is the product with the widest range of flanges.

Due to its compactness, the item TA25 allows it to be used in a lot of applications, to illuminate walls and paths.

As well as its IP rating, it can be used in high humidity environments such as showers or saunas as well as in basement window wells.

Karma company offers you two different plastic recessed boxes for installation, in addition to the standard one, there is special housing for recessed to the flooring installation. The back cover is not supplied with the fixture, you have to request it separately. Various angles of emission and light shades are available.

Spot



E = 10°

Finitura paletto / Bollard finishing



Grigio argento
Silver gray



Corten
Corten



Antracite
Anthracite

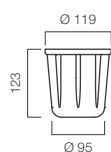

Code TA251
Controcassa in plastica
Plastic recessed box

Esempio codici ordine / Example order codes

Codice paletto / Bollard code

Codice motore / Engine code

Codice controcassa / Box code

TA25BN

+ TA258W2E5

+ TA251

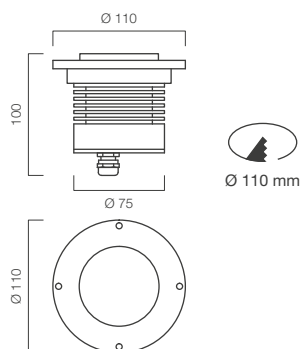

Code TA25BB
Paletto Side Emitter
con finitura grigio argento
Side Emitter bollard,
with silver gray color finish

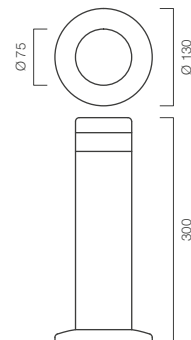

Code TA25BM
Paletto Side Emitter
con finitura corten
Side Emitter bollard,
with painted corten
color finish

Code TA25BN
Paletto Side Emitter con finitura antracite
Side Emitter bollard, with anthracite color finish

Led color

1 = 3000°K (741 lumen)

2 = 6000°K (849 lumen)

3 = Blu / Blue

9 = 4000°K (798 lumen)

Power supply

5 = 24Vdc

Code	TA25
Power	8W (3 LED HP SMD)
Led color	1-2-3-9
Spot	E
Power supply	5

Diagramma a cono rilevato con LED HP SMD, bianco naturale.
Cone diagram measured with natural white, HP SMD LED.

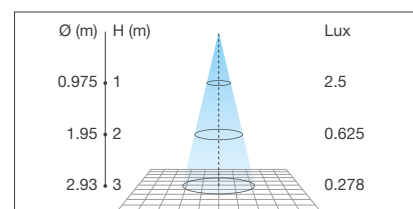



Codice accessori elettrici / *Electrical accessories code*

TA25 8W

Power supply IP67

ALP015.24	1	ALP120.24	1 - 12
ALP030.24	1 - 3	ALP150.24	1 - 15
ALP060.24	1 - 6	ALP200.24	1 - 21

Dimmer Controller IP20

AL240P	1 - 25
AL288D/P	1 - 30
CTR112DIM	1 - 30

RGB Controller IP20

CTR112RGB
CTR203CT
CTR213

Karma presenta il brevetto 2017 della nuova serie Taurus

Ecco una grande novità nel mondo dei corpi illuminanti: finalmente viene data una risposta adeguata al pubblico che si rivolge al mercato dell'illuminazione a LED per i fari da incasso esterno e che ricerca prodotti puliti, eleganti e ben rifiniti, senza viti in vista. Grazie alla grande esperienza produttiva dei tecnici presenti in azienda, si è potuto creare un sistema dinamico ed innovativo: un motore estremamente compatto ed affidabile sia come prestazioni che come tenuta all'acqua. Ma la novità in assoluto è rappresentata dagli accessori intercambiabili che permettono la scelta e la modifica del prodotto con tempi rapidi.

Grazie alla sua semplicità, il prodotto è facilmente riparabile e modificabile nell'aspetto estetico; un esempio ne è il modello senza viti che incontra le richieste sempre più frequenti dei progettisti. Inoltre l'alimentazione a 24Vdc con due fili, di serie su tutta la gamma Taurus permette la dimmerazione con tecnologia PWM.

Taurus 2017, grazie a Karma, aprirà una nuova frontiera nei prodotti da esterno MADE IN ITALY.

La gamma

La serie Taurus è stata creata con l'obiettivo di poter dare una risposta semplice ma completa a tutta la clientela. La gamma si sviluppa in 4 prodotti: un MONOLED di potenza 3W diam. 60 mm, un MONOLED di nuova tecnologia con potenza 9W diam. 80 mm, un tritico da 9W diam. 130 mm e infine un 7 LED da 21W diam. 170 mm.

Per ogni prodotto c'è la possibilità di scegliere la tonalità di luce, che può essere 3000°K, 4000°K, 6000°K, BLU e RGB e l'angolo della lente, secondo l'applicazione e l'effetto che si vuole ottenere. A livello estetico, ogni prodotto viene abbinato ad una serie specifica di flange, tonde o quadrate, con o senza viti, filo pavimento o ad emissione laterale, funghi o paletti in altezza 30 cm.

Karma presents the patent 2017 of new Taurus line

Here is a great novelty in the world of lighting fixtures: at last an appropriate response is given to people which is targeting the LED lighting market for outdoor recessed headlights and looking for clean, stylish and well finished products with no screws at view. Thanks to the great production experience of the technicians in the company, it was possible to create a dynamic and innovative system: an extremely compact and reliable engine both as a performance and waterproof. But the absolute novelty is represented by interchangeable accessories that allow you to choose and modify your product quickly.

Due to its simplicity, the product is easily repairable and editable in aesthetic appearance; an example is the sculptural model that meets the ever-increasing demands of designers. In addition, the system of 24Vdc power supply with two wires, standard on the entire Taurus range, allows dimmering with PWM technology. Taurus 2017, thanks to Karma company, will open a new frontier for outdoor MADE IN ITALY products.

The range

The Taurus Series is created with the aim of giving a simple but complete answer to all the customers. The range is developed in 4 products: a 3W power MONOLED diam. 60 mm, a 9W power new technological MONOLED diam. 80 mm, a 3-LED module with 9W power and diam. 130 mm and a 7-LED module with 21W diam. 170 mm.

For each product there is a choice of light shade, which can be 3000°K, 4000°K, 6000°K, BLUE and RGB and the angle of the lens, depending on the application and the effect you desire. At aesthetic level, each product is matched to a specific series of flanges, round or square, with or without screws, flooring or side emitter installation, side emitter mushrooms or column light in height 30 cm.

Alimentazione innovativa a 24Vdc dimmerabile su 2 fili



Innovative power at 24Vdc 2 cables dimmable

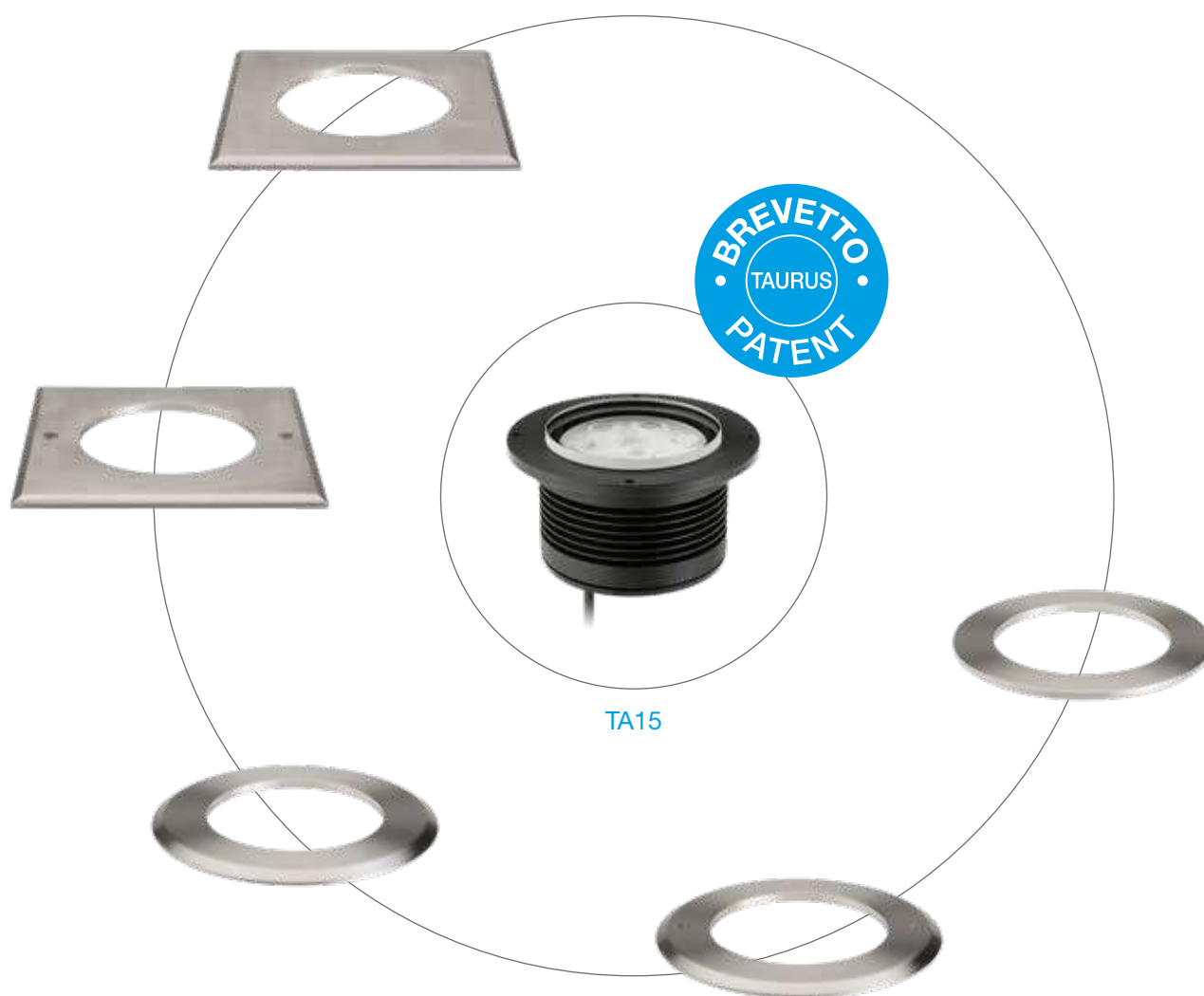

Il prodotto TA15 è il più importante a livello dimensionale della gamma, con il frontale in diametro di 170 mm alloggia un modulo a 7 LED da 21W. Come per ogni prodotto c'è la possibilità di scegliere la tonalità di luce, che può essere 3000°K, 4000°K, 6000°K, BLU e RGB e l'angolo della lente, secondo l'applicazione e l'effetto che si vuole ottenere.

A livello estetico, TA15 viene abbinato ad una serie specifica di flange, tonde o quadrate, con o senza viti e filo pavimento.

The TA15 product is the biggest one in the range, with its frontal in diameter 170 mm and 7-LED module with 21W power.

As for each product there is a choice of light shade, which can be 3000°K, 4000°K, 6000°K, BLUE and RGB and the angle of the lens, depending on the application and the effect you desire.

At aesthetic level, TA15 is matched to a specific series of flanges, round or square, with or without screws, flooring installation.

TA15



Motore ad elevata potenza, calibrato e proporzionato per 7 LED High Power per applicazioni esterne, interne con alto tasso di umidità. Prodotto dimensionalmente importante ad elevate prestazioni. Dispositivo che, data la sua compattezza, permette di essere utilizzato in un numero considerevole di applicazioni, per illuminare pareti e percorsi, colonne, facciate, edifici in genere.

Grazie al grado di IP dichiarato, può essere utilizzato in ambienti con elevato tasso di umidità, quali docce o saune, nonché in bocche di lupo. Sono previste due controcasse per l'installazione in gettata, oltre a quella standard è prevista una controcassa speciale per installazione filo pavimento. La controcassa non è in dotazione con il faro.

Sono disponibili vari angoli di emissione e tonalità della luce.

High performance fixture, calibrated and proportioned for 7 pieces of High Power LEDs for outdoor or indoor applications, also in places with high humidity.

Dimensionally important products, with high performance. Due to its compactness, the item TA15 allows it to be used in a lot of applications, to illuminate walls and paths, columns, buildings in general.

As well as its IP rating, it can be used in high humidity environments such as showers or saunas as well as in basement window wells.

Karma company offers you two different plastic recessed boxes for installation, in addition to the standard one, there is special housing for recessed to the flooring installation. The back cover is not supplied with the fixture, you have to request it separately.

Various angles of emission and light shades are available.

Spot

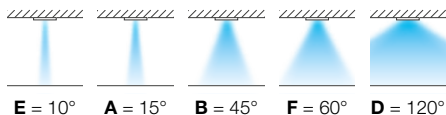

Finitura flangia / Flange finishing



Acciaio inox AISI316L
Stainless steel AISI316L

Esempio codici ordine / Example order codes

Codice flangia / Flange code Codice motore / Engine code Codice controcassa / Box code

TA15RFL + **TA1521W9D5** + **TA152**

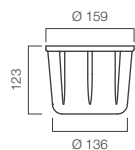
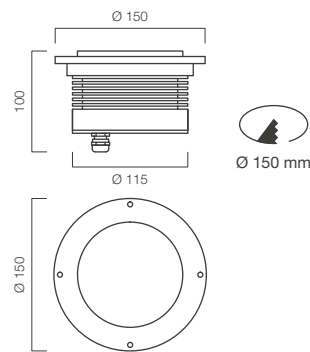

Code TA151
Controcassa
in plastica
Plastic recessed
box

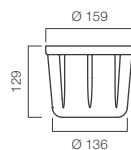

Code TA152
Controcassa in plastica
filo pavimento
Plastic recessed box
flooring installation

Code TA15RFL
Flangia tonda filo pavimento
Round recessed flooring
installation flange



Code TA15SL
Flangia quadra senza fori
Square flange without holes

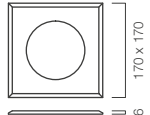

Code TA15SHL
Flangia quadra con fori
Square flange for screw fixing

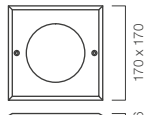

Code TA15RL
Flangia tonda senza fori
Round flange without holes



Code TA15RHL
Flangia tonda con fori
Round flange for screw fixing

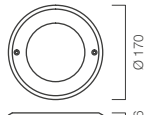

Led color

1 = 3000°K (1729 lumen)
3 = Blu / Blue
7 = RGB
9 = 4000°K (1862 lumen)

Power supply

5 = 24Vdc

Code	TA15
Power	21W (7 LED HP SMD)
Led color	1-3-9
Spot	A-B-D-E-F
Power supply	5

Code	TA15
Power	19W (6 LED RGB)
Led color	7
Spot	B-D
Power supply	5

Diagramma a coni rilevato con LED HP SMD, lente 45°, bianco naturale.
Cone diagram measured with natural white, HP SMD LED, lens 45°.

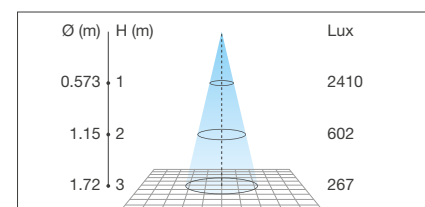



Codice accessori elettrici / *Electrical accessories code*

TA15 21W

Power supply IP67

ALP030.24	1	ALP150.24	1 - 6
ALP060.24	1 - 2	ALP200.24	1 - 8
ALP120.24	1 - 4		

Dimmer Controller IP20

AL240P	1 - 9
AL288D/P	1 - 11
CTR112DIM	1 - 11

RGB Controller IP20

CTR112RGB
CTR203CT
CTR213





Aquarius

Apparecchi a LED da incasso per esterni
LED recessed devices for outdoor





Apparecchio carrabile (250 kg, 15 kmh), compatto e versatile, da incasso per interni ed esterni.

Corpo e frontale rotondo in acciaio inox, vetro temperato chiaro.

Fissaggio con molle su apposita controcassa (in dotazione), sia a pavimento che a parete.

Adatto per vialetti, giardini, aree verdi, fontane e per indicare percorsi.

Led color

- 1 = 3000°K (247 lumen)
- 2 = 6000°K (283 lumen)
- 3 = Blu / Blue
- 7 = RGB
- 9 = 4000°K (266 lumen)

Power supply

- 1 = 350mA
- 2 = 650mA

Code	AQ35
Power	3W (1 LED HP SMD)
Led color	1-2-3-9
Spot	A-B-D-S-W
Power supply	2
Finishing	L

Compact and versatile recessed driver over device (250 kg, 15 kmh), for indoor and outdoor.

Body and front in stainless steel, clear tempered glass.

Fixing with springs on its suitable plastic recessed box (supplied with the device), on the floor or on the wall.

It can be used for driveways, gardens, green areas, fountains, path trails.

Code	AQ35
Power	3W (1 LED RGB)
Led color	7
Spot	B-D
Power supply	1
Finishing	L

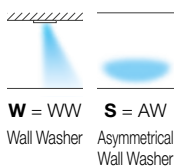
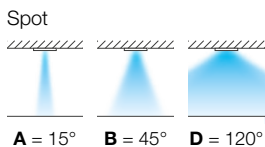
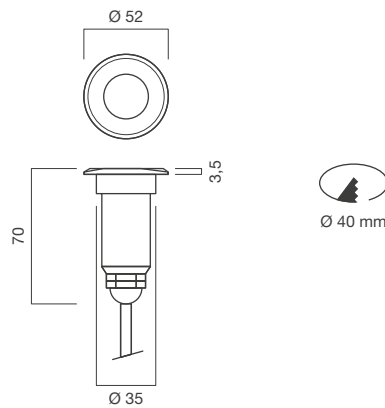

Finiture / Finishing

- Acciaio inox AISI304
Stainless steel AISI304
- L**



Diagramma a cono rilevato con LED HP SMD, lente 45°, bianco caldo.
Cone diagram measured with warm white, HP SMD LED, lens 45°.



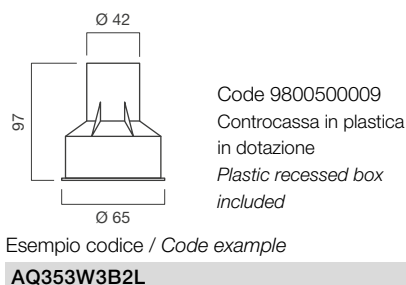
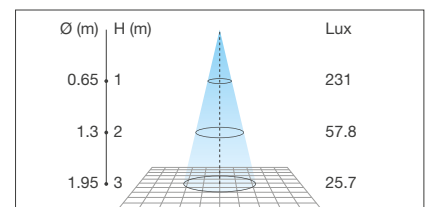

Codice accessori elettrici / *Electrical accessories code*

Power supply IP67

APP006.650 1 - 2

ACP0.32.700 6 - 13

Dimmer Controller IP20

AL240P + DRV650 1 - 68

DCJOLLY 4 - 8

RGB Controller IP20

CTR031

CTR203C1W

RGB Driver/Driver IP67

DVR650.IP

DRVRGB.IP

AQ35 650mA 3W



Prodotto di punta della serie Aquarius.

Apparecchio carrabile (250 kg, 15 kmh), compatto, da incasso per interni ed esterni.

Corpo in alluminio anodizzato e frontale rotondo in acciaio inox, vetro temperato chiaro. Fissaggio con viti su apposita controcassa (in dotazione), sia a pavimento che a parete. Adatto per vialetti, giardini, aree verdi, fontane e per indicare percorsi.

Top sales product of Aquarius series.

Compact recessed driver over device (250 kg, 15 kmh), for indoor and outdoor.

Anodized aluminum body and round front in stainless steel, clear tempered glass.

Fixing with screws on its suitable plastic recessed box (supplied with the device), on the floor or on the wall.

It can be used for driveways, gardens, green areas, fountains, path trails.

Led color

- 1** = 3000°K (741 lumen)
- 2** = 6000°K (849 lumen)
- 3** = Blu / Blue
- 7** = RGB
- 9** = 4000°K (798 lumen)

Power supply

- 1** = 350mA
- 5** = 24Vdc

Code	AQ25N
Power	8W (3 LED HP SMD)
Led color	1-2-3-9
Spot	A-B-D-S-W
Power supply	5
Finishing	L

Code	AQ25N
Power	9W (3 LED RGB)
Led color	7
Spot	B-D
Power supply	1
Finishing	L

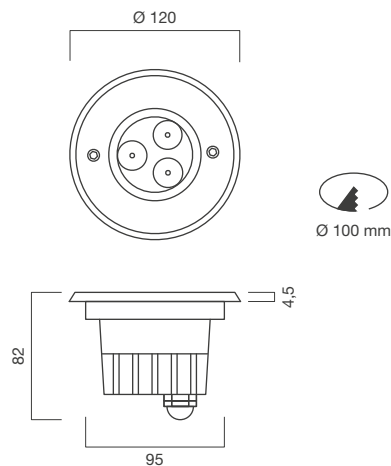

Spot

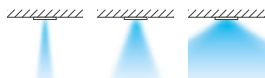

A = 15° **B** = 45° **D** = 120°

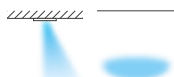

W = WW **S** = AW
Wall Washer Asymmetrical Wall Washer

Finiture / Finishing

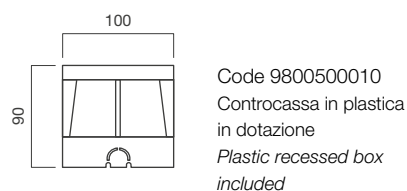
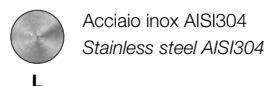

Esempio codice / Code example

AQ25N8W2D5L



Diagramma a cono rilevato con LED HP SMD, lente 45°, bianco caldo.

Cone diagram measured with warm white, HP SMD LED, lens 45°.

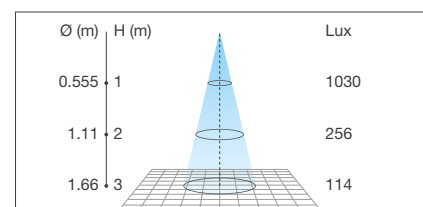



Codice accessori elettrici / *Electrical accessories code*

Power supply IP67

ALP015.24	1	ALP120.24	1 - 12
ALP030.24	1 - 3	ALP150.24	1 - 15
ALP060.24	1 - 6	ALP200.24	1 - 21

Dimmer Controller IP20

AL240P	1 - 25
AL288D/P	1 - 30
CTR112DIM	1 - 30

RGB Controller IP20

CTR031
CTR203C1W

RGB Driver IP67

DRVRGB.IP

AQ25N 8W



Apparecchio carrabile (250 kg, 15 kmh), compatto, da incasso per interni ed esterni.

Corpo in alluminio anodizzato e frontale quadrato in acciaio inox, vetro temperato chiaro. Fissaggio con viti su apposita controcassa (in dotazione), sia a pavimento che a parete. Adatto per vialetti, giardini, aree verdi, fontane e per indicare percorsi.

Compact recessed driver over device (250 kg, 15 kmh), for indoor and outdoor.

Anodized aluminum body and square front in stainless steel, clear tempered glass.

Fixing with screws on its suitable plastic recessed box (supplied with the device), on the floor or on the wall.

It can be used for driveways, gardens, green areas, fountains, path trails.

Led color
1 = 3000°K (741 lumen)
2 = 6000°K (849 lumen)
3 = Blu / Blue
7 = RGB
9 = 4000°K (798 lumen)

Power supply
1 = 350mA
5 = 24Vdc

Code	AQ26N
Power	8W (3 LED HP SMD)
Led color	1-2-3-9
Spot	A-B-D-S-W
Power supply	5
Finishing	L

Code	AQ26N
Power	9W (3 LED RGB)
Led color	7
Spot	B-D
Power supply	1
Finishing	L

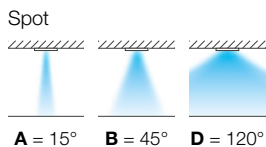
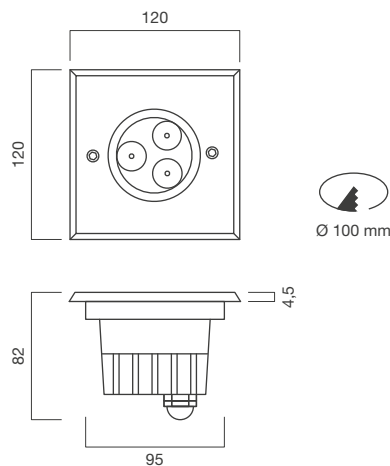

W = WW
Wall Washer

S = AW
Asymmetrical Wall Washer

Finiture / Finishing

 Acciaio inox AISI304
Stainless steel AISI304

L

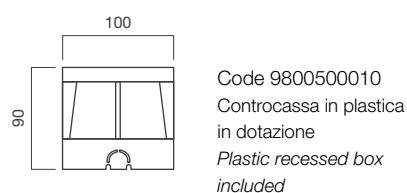

Esempio codice / Code example
AQ26N9W7B1L

Diagramma a cono rilevato con LED HP SMD, lente 45°, bianco caldo.
Cone diagram measured with warm white, HP SMD LED, lens 45°.

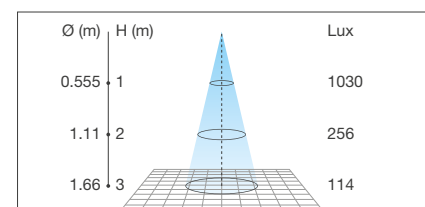



Codice accessori elettrici / *Electrical accessories code*

Power supply IP67

ALP015.24	1	ALP120.24	1 - 12
ALP030.24	1 - 3	ALP150.24	1 - 15
ALP060.24	1 - 6	ALP200.24	1 - 21

Dimmer Controller IP20

AL240P	1 - 25
AL288D/P	1 - 30
CTR112DIM	1 - 30

RGB Controller IP20

CTR031
CTR203C1W

RGB Driver IP67

DRVRGB.IP

AQ26N 8W



Apparecchio carrabile (250 kg, 15 kmh), compatto, da incasso per interni ed esterni.

Corpo in alluminio anodizzato e frontale in acciaio inox, diffusore side emitter in plexiglass.

Fissaggio con viti su apposita controcassa (in dotazione), sia a pavimento che a parete.

Adatto come segnapasso con emissione laterale a 360°.

Compact recessed driver over device (250 Kg, 15 Km/h), for indoor and outdoor.

Anodized aluminum body and front in stainless steel, side emitter plexiglass diffuser.

Fixing with screws on its suitable plastic recessed box (supplied with the device), on the floor or on the wall.

Suitable as side-marker with lateral light emission at 360°.

Led color

1 = 3000°K (741 lumen)

2 = 6000°K (849 lumen)

9 = 4000°K (798 lumen)

Power supply

5 = 24Vdc

Code **AQ24N**

Power **8W** (3 LED HP SMD)

Led color **1-2-9**

Spot **H**

Power supply **5**

Finishing **L**

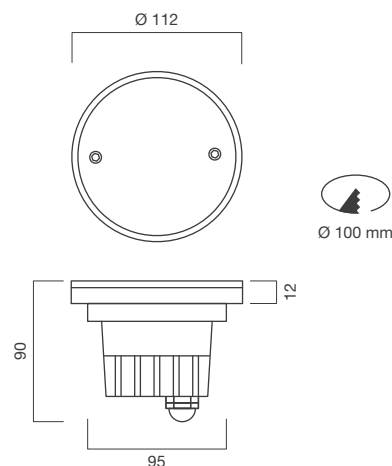

Spot



H = 360°

Finiture / Finishing



Acciaio inox AISI304
Stainless steel AISI304

L

Code 9800500010
Controcassa in plastica
in dotazione
Plastic recessed box
included

Esempio codice / Code example

AQ24N8W9H5L

Diagramma a coni rilevato con LED HP SMD, bianco naturale, emissione 360°.

Cone diagram measured with natural white, HP SMD LED, 360° emission.

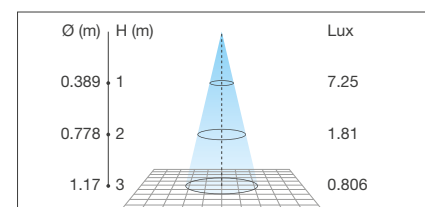



Codice accessori elettrici / *Electrical accessories code*

AQ24N 8W

Power supply IP67

ALP015.24	1	ALP120.24	1 - 12
ALP030.24	1 - 3	ALP150.24	1 - 15
ALP060.24	1 - 6	ALP200.24	1 - 21

Dimmer Controller IP20

AL240P	1 - 25
AL288D/P	1 - 30
CTR112DIM	1 - 30

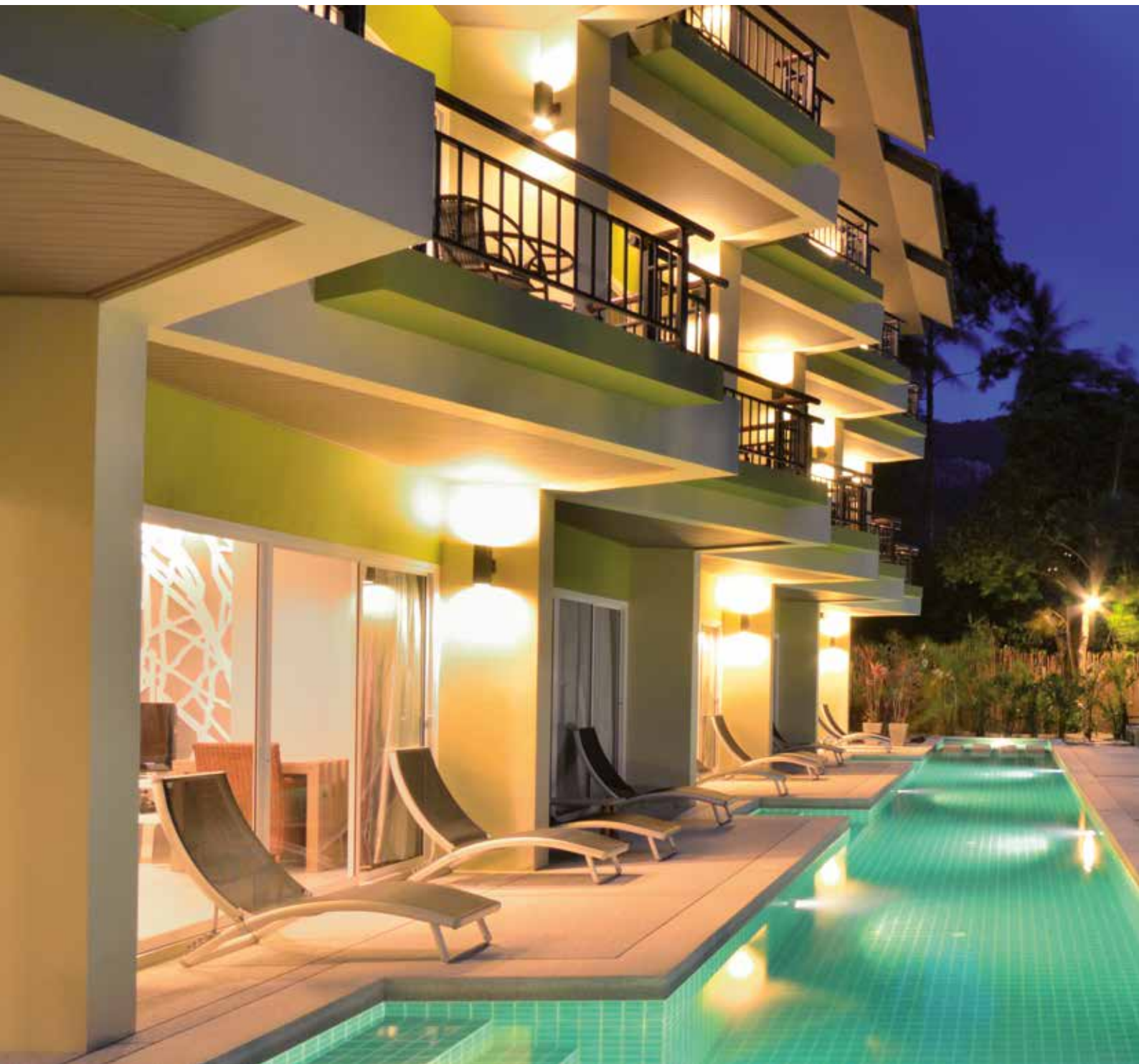

KARMA[®]
POWERLED LIGHTING



Phoenix

Proiettori a LED da esterno
LED devices for outdoor



Karma presenta la serie Phoenix, uno stile innovativo di prodotti Made in Italy

Con la serie Phoenix, Karma presenta 5 nuove linee complete di prodotti da esterno con elevato indice di protezione.

Un medesimo stile di prodotto per fari da parete mono- e bi-emissione, fari da plafone, paletti e proiettori orientabili.

Ogni linea si distingue per utilizzo, estetica, dimensioni e caratteristiche tecniche.

L'innovativo sistema di montaggio, con l'utilizzo di colle ad altissimo fissaggio, permette di eliminare le viti rendendo la serie Phoenix pulita, minimale ed elegante. Con l'impiego di LED COB ad alta potenza, il prodotto raggiunge la massima performance, dando un risultato all'altezza delle aspettative. Il cliente deve solo decidere la linea di prodotto più adatta alle proprie esigenze o alla location.

Karma company presents Phoenix serie, a new style of products Made in Italy

With the Phoenix serie, Karma company presents 5 new lines of outdoor products with high protection index. A same product style for mono- and bi-emission wall devices, ceiling devices, bollards and adjustable devices. Each line stands out for its use, aesthetics, dimensions and technical features. The innovative assembly system, with the use of very strength glue, eliminates screws and makes the Phoenix serie clean, minimal and elegant. With the use of high power COB LEDs, the product reaches maximum performance, giving a result up to expectations. The customer only has to decide the product line, which best suits his needs or location.

Karma ha creato la serie Phoenix con lo scopo di eliminare le viti a vista, solitamente usate per assemblare i prodotti, usando in alternativa incollanti speciali, ad alta resistenza. Il prodotto ottenuto si presenta con un unico monoblocco centrale lineare, elegante ed omogeneo, senza punti di debolezza.

Ogni profilo estruso che viene impiegato è stato studiato e disegnato per questo scopo, nulla è stato lasciato al caso. Si sviluppa quindi una gamma di prodotti modulare ed espandibile con un particolare e riconoscibile Family Feeling.

Tutta la produzione, dalla estrusione, all'assemblaggio, alla lavorazione, viene realizzata in Italia, per mantenere un elevato livello qualitativo del prodotto durante ogni fase della sua realizzazione.

Questo procedimento ci permette inoltre di realizzare produzioni custom, di adattare il prodotto alle esigenze di mercato e di ampliare la gamma con soluzioni sempre nuove.

Karma has created the Phoenix series with the aim of eliminating the screws at sight, usually used to assemble the products, using as alternative very-strength special glue. The product obtained is a single piece of linear, elegant and homogeneous central monoblock, with no weak points.

Any extruded profile that is being used has been studied and designed for this purpose, nothing has been left to chance. So a range of modular and expandable products is developed with a distinctive and recognizable Family Feeling.

The complete production phase, from extrusion, to assembling and manufacturing, is carried out in Italy, in order to maintain a high quality level of product during every stage of its realization.

This process also allows us to produce custom items, to adapt the product to the needs of the market, and expand the range with always new solutions.





Apparecchio monodirezionale per esterni da parete.

Corpo rettangolare in alluminio estruso con frontale in vetro. Fissaggio a parete con apposita staffa. L'innovativo sistema di montaggio, tramite l'utilizzo di colle ad altissimo fissaggio, permette l'eliminazione delle viti, rendendo il prodotto pulito ed elegante. Disponibile con LED da 9W, in diverse tonalità di bianco con alimentazione 230Vac oppure in versione RGB con alimentazione 24Vdc. Disponibile in varie finiture da abbinare al contesto. Ideale per illuminazione di pareti ed ottenere effetti decorativi.

Monodirectional wall mounting device for outdoor.

Rectangular body in extruded aluminum with frontal glass. Wall fixing with special bracket. The innovative assembling system, with the use of very strength glue, eliminates screws and makes the Phoenix serie clean, minimal and elegant. Available with 9W power LEDs in different white color temperature with input voltage 230Vac or RGB version with input voltage 24Vdc. Available in various finishes to match the context. Ideal for wall lighting and decorative effects.

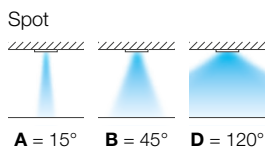

Finiture / Finishing

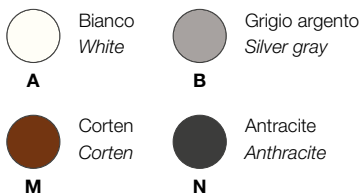

Led color

- 1 = 3000°K (741 lumen)
- 2 = 6000°K (849 lumen)
- 7 = RGB
- 9 = 4000°K (798 lumen)

Power supply

- 5 = 24Vdc
- 6 = 230Vac

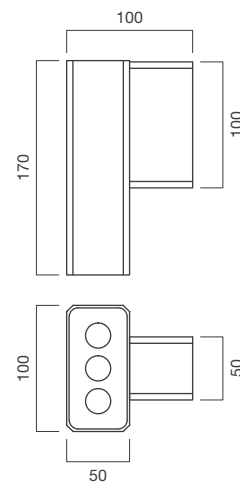

Esempio codice / Code example

PH01S9W7D5B

Code	PH01S
Power	9W (3 LED HP SMD)
Led color	1-2-9
Spot	A-B-D
Power supply	6
Finishing	A-B-M-N

Code	PH01S
Power	9W (3 LED RGB)
Led color	7
Spot	B-D
Power supply	5
Finishing	A-B-M-N

Diagramma a coni rilevato con LED HP SMD, lente 45°, bianco caldo.

Cone diagram measured with warm white, HP SMD LED, lens 45°.

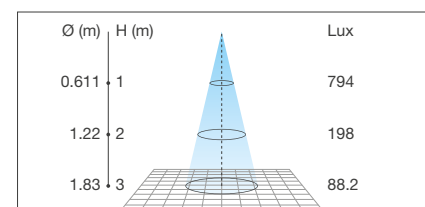



Apparecchio bidirezionale per esterni da parete.

Corpo rettangolare in alluminio estruso con frontale in vetro. Fissaggio a parete con apposita staffa. L'innovativo sistema di montaggio, tramite l'utilizzo di colle ad altissimo fissaggio, permette l'eliminazione delle viti, rendendo il prodotto pulito ed elegante. Disponibile con LED da 18W (9+9W), in diverse tonalità di bianco con alimentazione 230Vac oppure in versione RGB con alimentazione 24Vdc. Disponibile in varie finiture da abbinare al contesto. Ideale per illuminazione di pareti ed ottenere effetti decorativi.

Bidirectional wall mounting device for outdoor.

Rectangular body in extruded aluminum with frontal glass. Wall fixing with special bracket. The innovative assembling system, with the use of very strength glue, eliminates screws and makes the Phoenix serie clean, minimal and elegant. Available with 18W power LEDs (9+9W) in different white color temperature with input voltage 230Vac or RGB version with input voltage 24Vdc. Available in various finishes to match the context. Ideal for wall lighting and decorative effects.

Spot

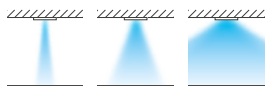

A = 15° B = 45° D = 120°

Finiture / Finishing

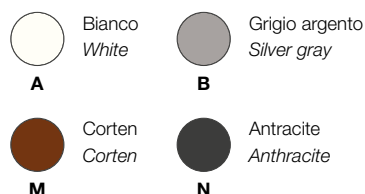

Led color

- 1 = 3000°K (1482 lumen)
- 2 = 6000°K (1698 lumen)
- 7 = RGB
- 9 = 4000°K (1596 lumen)

Power supply

- 5 = 24Vdc
- 6 = 230Vac

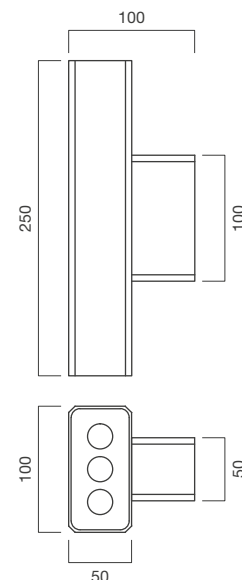

Esempio codice / Code example

PH02S18W2D5M

Code	PH02S
Power	18W (3+3 LED HP SMD)
Led color	1-2-9
Spot	A-B-D
Power supply	5-6
Finishing	A-B-M-N

Code	PH02S
Power	18W (3+3 LED RGB)
Led color	7
Spot	B-D
Power supply	5
Finishing	A-B-M-N

Diagramma a coni rilevato con LED HP SMD, lente 45°, bianco caldo.

Cone diagram measured with warm white, HP SMD LED, lens 45°.

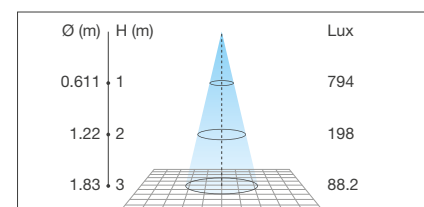

PH03S

PH11S



Apparecchi monodirezionali di potenza per esterni da parete.

Corpo quadrato in alluminio estruso con frontale in vetro. Fissaggio a parete con apposita staffa. L'innovativo sistema di montaggio, tramite l'utilizzo di colle ad altissimo fissaggio, permette l'eliminazione delle viti, rendendo il prodotto pulito ed elegante. Disponibile con LED COB di potenza 10W (PH03S) o 20W (PH11S) in varie tonalità di bianco e in varie finiture da abbinare al contesto. Ideale per illuminazione di pareti.

Monodirectional wall mounting hi power device for outdoor.

Square body in extruded aluminum with frontal glass. Wall fixing with special bracket. The innovative assembling system, with the use of very strength glue, eliminates screws and makes the Phoenix serie clean, minimal and elegant. Available with 10W power COB LEDs (PH03S) or 20W (PH11S) in different white color temperature and in various finishes to match the context. Ideal for wall lighting.

Spot

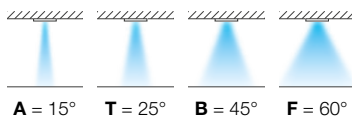

Finiture / Finishing

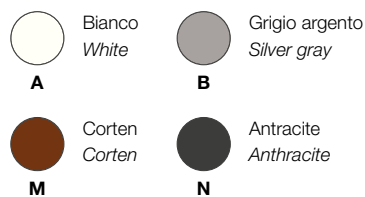

Esempio codice / Code example

PH11S20W9F6B

Led color
1 = 3000°K (980 lumen)
2 = 5700°K (1010 lumen)
9 = 4000°K (1000 lumen)

Power supply
6 = 230Vac

Code	PH03S
Power	10W (1 LED COB)
Led color	1-2-9
Spot	A-B-T
Power supply	6
Finishing	A-B-M-N

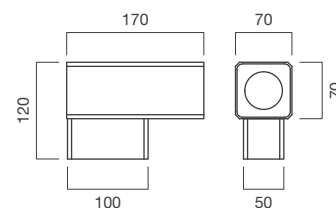

Led color
1 = 3000°K (1950 lumen)
2 = 5700°K (2000 lumen)
9 = 4000°K (1980 lumen)

Power supply
6 = 230Vac

Code	PH11S
Power	20W (1 LED COB)
Led color	1-2-9
Spot	B-F-T
Power supply	6
Finishing	A-B-M-N



Diagramma a cono rilevato con LED COB, lente 45°, bianco naturale.
Cone diagram measured with natural white, COB LED, lens 45°.



Diagramma a cono rilevato con LED COB, lente 45°, bianco naturale.
Cone diagram measured with natural white, COB LED, lens 45°.

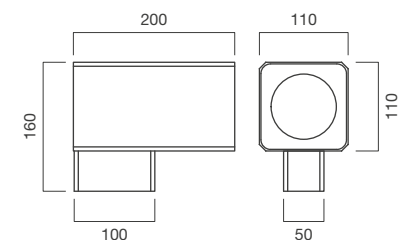

PH04S

PH12S

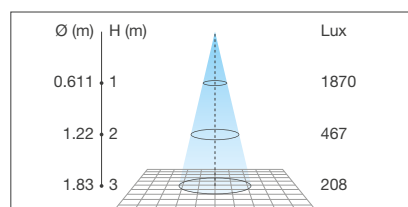
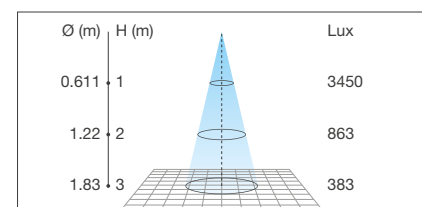
Phoenix



Apparecchi bidirezionali di potenza per esterni da parete.

Corpo quadrato in alluminio estruso con frontale in vetro. Fissaggio a parete con apposita staffa. L'innovativo sistema di montaggio, tramite l'utilizzo di colle ad altissimo fissaggio, permette l'eliminazione delle viti, rendendo il prodotto pulito ed elegante. Disponibile con 2 LED COB di potenza 10W (PH04S) o 20W (PH12S) in varie tonalità di bianco e in varie finiture da abbinare al contesto. Ideale per illuminazione di pareti.

Bidirectional wall mounting hi power device for outdoor.

Square body in extruded aluminum with frontal glass. Wall fixing with special bracket. The innovative assembling system, with the use of very strength glue, eliminates screws and makes the Phoenix serie clean, minimal and elegant. Available with 2 x 10W power COB LEDs (PH04S) or 20W (PH12S) in different white color temperature and in various finishes to match the context. Ideal for wall lighting.

Led color
1 = 3000°K (1960 lumen)
2 = 5700°K (2020 lumen)
9 = 4000°K (2000 lumen)

Power supply
6 = 230Vac

Code	PH04S
Power	10W (x 2 LED COB)
Led color	1-2-9
Spot	A-B-D-T
Power supply	6
Finishing	A-B-M-N



Led color
1 = 3000°K (3900 lumen)
2 = 5700°K (4000 lumen)
9 = 4000°K (3960 lumen)

Power supply
6 = 230Vac

Code	PH12S
Power	20W (x 2 LED COB)
Led color	1-2-9
Spot	B-D-F-T
Power supply	6
Finishing	A-B-M-N

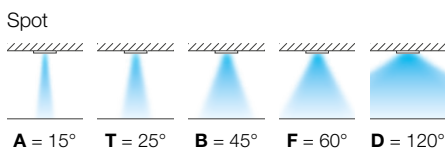
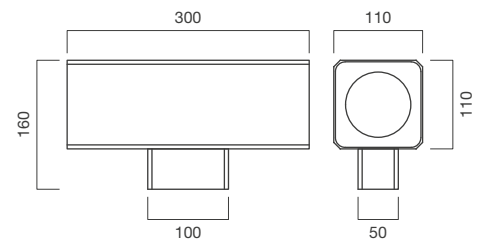
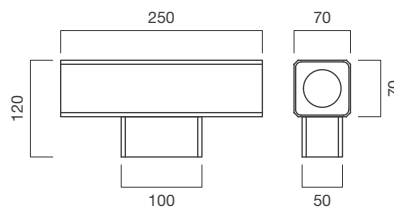

Finiture / Finishing

- Bianco / White
 - Grigio argento / Silver gray
 - Corten / Corten
 - Antracite / Anthracite
- A** **B**
M **N**

Esempio codice / Code example

PH04S10W2A6M

Diagramma a cono rilevato con LED COB, lente 45°, bianco naturale.
 Cone diagram measured with natural white, COB LED, lens 45°.



Diagramma a cono rilevato con LED COB, lente 45°, bianco naturale.
 Cone diagram measured with natural white, COB LED, lens 45°.



PH05R

PH11R

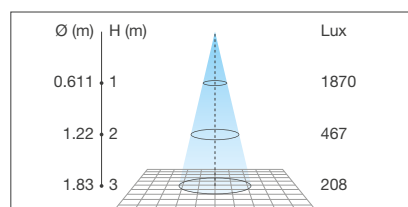
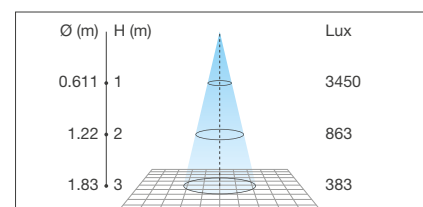
10
W/tot20
W/tot

Apparecchi monodirezionali di potenza per esterni da parete.

Corpo tondo in alluminio estruso con frontale in vetro. Fissaggio a parete con apposita staffa. L'innovativo sistema di montaggio, tramite l'utilizzo di colle ad altissimo fissaggio, permette l'eliminazione delle viti, rendendo il prodotto pulito ed elegante. Disponibile con LED COB di potenza 10W (PH05R) o 20W (PH11R) in varie tonalità di bianco e in varie finiture da abbinare al contesto. Ideale per illuminazione di pareti.

Monodirectional wall mounting hi power device for outdoor.

Round body in extruded aluminum with frontal glass. Wall fixing with special bracket. The innovative assembling system, with the use of very strength glue, eliminates screws and makes the Phoenix serie clean, minimal and elegant. Available with 10W power COB LEDs (PH05R) or 20W (PH11R) in different white color temperature and in various finishes to match the context. Ideal for wall lighting.

Led color
1 = 3000°K (980 lumen)
2 = 5700°K (1010 lumen)
9 = 4000°K (1000 lumen)

Power supply
6 = 230Vac

Code	PH05R
Power	10W (1 LED COB)
Led color	1-2-9
Spot	A-B-D-T
Power supply	6
Finishing	A-B-M-N

Led color
1 = 3000°K (1950 lumen)
2 = 5700°K (2000 lumen)
9 = 4000°K (1980 lumen)

Power supply
6 = 230Vac

Code	PH11R
Power	20W (1 LED COB)
Led color	1-2-9
Spot	B-D-F-T
Power supply	6
Finishing	A-B-M-N

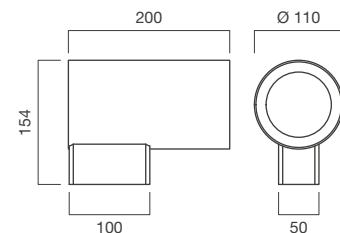
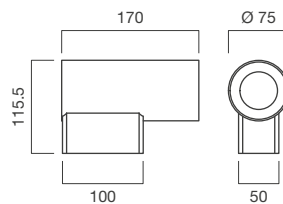

Spot

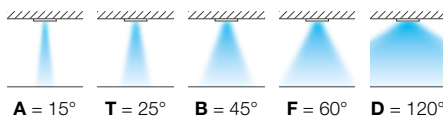

Finiture / Finishing

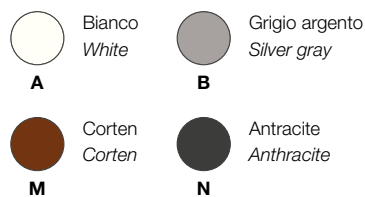

Esempio codice / Code example

PH05R10W1D6B

Diagramma a cono rilevato con LED COB, lente 45°, bianco naturale.
 Cone diagram measured with natural white, COB LED, lens 45°.



Diagramma a cono rilevato con LED COB, lente 45°, bianco naturale.
 Cone diagram measured with natural white, COB LED, lens 45°.



PH06R

PH12R

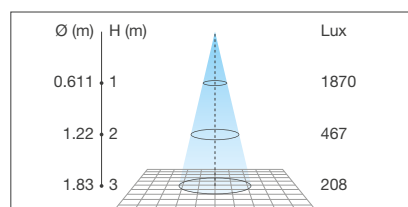
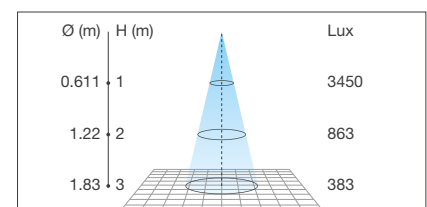
Phoenix



Apparecchi bidirezionali di potenza per esterni da parete.

Corpo tondo in alluminio estruso con frontale in vetro. Fissaggio a parete con apposita staffa. L'innovativo sistema di montaggio, tramite l'utilizzo di colle ad altissimo fissaggio, permette l'eliminazione delle viti, rendendo il prodotto pulito ed elegante. Disponibile con 2 LED COB di potenza 10W (PH06R) o 20W (PH12R) in varie tonalità di bianco e in varie finiture da abbinare al contesto. Ideale per illuminazione di pareti.

Bidirectional wall mounting hi power device for outdoor.

Round body in extruded aluminum with frontal glass. Wall fixing with special bracket. The innovative assembling system, with the use of very strength glue, eliminates screws and makes the Phoenix serie clean, minimal and elegant. Available with 2 x 10W power COB LEDs (PH06R) or 20W (PH12R) in different white color temperature and in various finishes to match the context. Ideal for wall lighting.

Led color
1 = 3000°K (1960 lumen)
2 = 5700°K (2020 lumen)
9 = 4000°K (2000 lumen)

Power supply
6 = 230Vac

Code	PH06R
Power	10W (x 2 LED COB)
Led color	1-2-9
Spot	A-B-D-T
Power supply	6
Finishing	A-B-M-N

Led color
1 = 3000°K (3900 lumen)
2 = 5700°K (4000 lumen)
9 = 4000°K (3960 lumen)

Power supply
6 = 230Vac

Code	PH12R
Power	20W (x 2 LED COB)
Led color	1-2-9
Spot	B-D-F-T
Power supply	6
Finishing	A-B-M-N

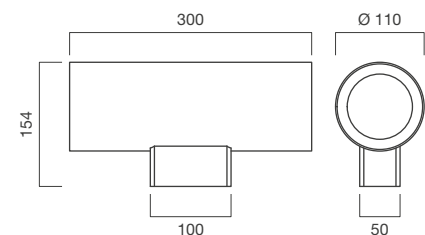
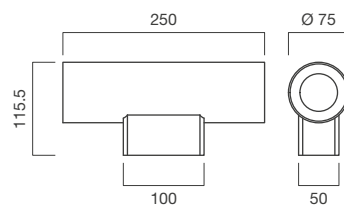

Spot

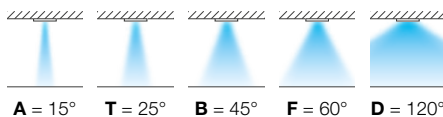

Finiture / Finishing

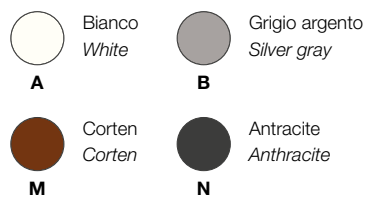

Esempio codice / Code example

PH12R20W9F6N

Diagramma a cono rilevato con LED COB, lente 45°, bianco naturale.
 Cone diagram measured with natural white, COB LED, lens 45°.



Diagramma a cono rilevato con LED COB, lente 45°, bianco naturale.
 Cone diagram measured with natural white, COB LED, lens 45°.



PH03C

PH11C

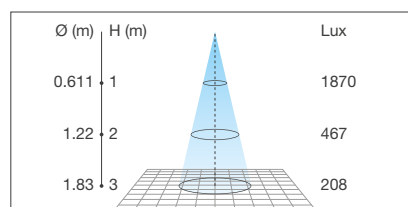
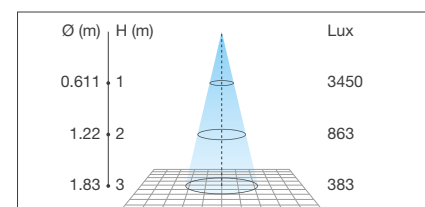
**Apparecchi a plafone di potenza per esterni.**

Corpo quadrato in alluminio estruso con frontale in vetro. Fissaggio a soffitto con apposita staffa. L'innovativo sistema di montaggio, tramite l'utilizzo di colle ad altissimo fissaggio, permette l'eliminazione delle viti, rendendo il prodotto pulito ed elegante.

Disponibile con LED COB di potenza 10W (PH03C) o 20W (PH11C) in varie tonalità di bianco e in varie finiture da abbinare al contesto. Ideale per l'installazione su portici o tettoie.

Ceiling mounting hi power device for outdoor.

Square body in extruded aluminum with frontal glass. Ceiling fixing with special bracket. The innovative assembling system, with the use of very strength glue, eliminates screws and makes the Phoenix serie clean, minimal and elegant. Available with 10W power COB LEDs (PH03C) or 20W (PH11C) in different white color temperature and in various finishes to match the context. Ideal for arcades or canopies.

Led color
1 = 3000°K (980 lumen)
2 = 5700°K (1010 lumen)
9 = 4000°K (1000 lumen)

Power supply
6 = 230Vac

Code	PH03C
Power	10W (1 LED COB)
Led color	1-2-9
Spot	A-B-D-T
Power supply	6
Finishing	A-B-M-N

Led color
1 = 3000°K (1950 lumen)
2 = 5700°K (2000 lumen)
9 = 4000°K (1980 lumen)

Power supply
6 = 230Vac

Code	PH11C
Power	20W (1 LED COB)
Led color	1-2-9
Spot	B-D-F-T
Power supply	6
Finishing	A-B-M-N

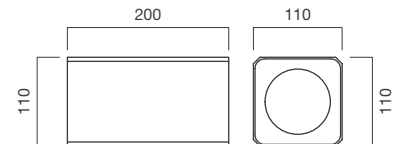
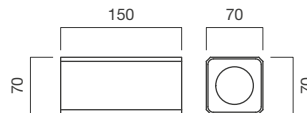
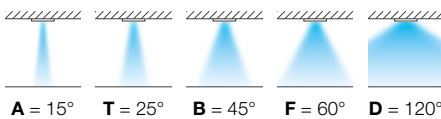
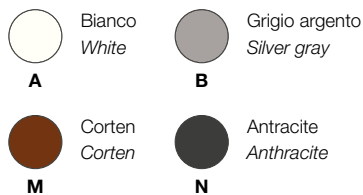
**Spot****Finiture / Finishing**

Esempio codice / Code example

PH11C20W1D6B

Diagramma a cono rilevato con LED COB, lente 45°, bianco naturale.
 Cone diagram measured with natural white, COB LED, lens 45°.



Diagramma a cono rilevato con LED COB, lente 45°, bianco naturale.
 Cone diagram measured with natural white, COB LED, lens 45°.



PH05T

PH11T

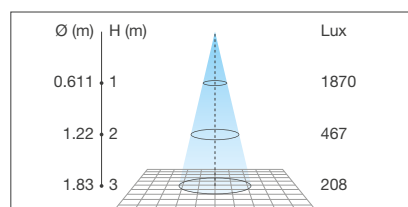
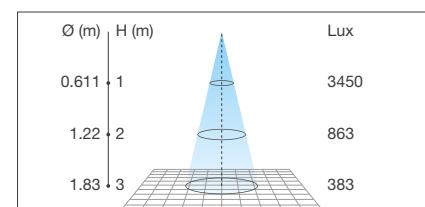
Phoenix

**Apparecchi a plafone di potenza per esterni.**

Corpo tondo in alluminio estruso con frontale in vetro. Fissaggio a soffitto con apposita staffa. L'innovativo sistema di montaggio, tramite l'utilizzo di colle ad altissimo fissaggio, permette l'eliminazione delle viti, rendendo il prodotto pulito ed elegante.

Disponibile con LED COB di potenza 10W (PH05T) o 20W (PH11T) in varie tonalità di bianco e in varie finiture da abbinare al contesto. Ideale per l'installazione su portici o tettoie.

Ceiling mounting hi power device for outdoor.

Round body in extruded aluminum with frontal glass. Ceiling fixing with special bracket. The innovative assembling system, with the use of very strength glue, eliminates screws and makes the Phoenix serie clean, minimal and elegant. Available with 10W power COB LEDs (PH05T) or 20W (PH11T) in different white color temperature and in various finishes to match the context. Ideal for arcades or canopies.

Led color

- 1** = 3000°K (980 lumen)
2 = 5700°K (1010 lumen)
9 = 4000°K (1000 lumen)

Power supply

- 6** = 230Vac

Code **PH05T**Power **10W** (1 LED COB)Led color **1-2-9**Spot **A-B-D-T**Power supply **6**Finishing **A-B-M-N**

Led color

- 1** = 3000°K (1950 lumen)
2 = 5700°K (2000 lumen)
9 = 4000°K (1980 lumen)

Power supply

- 6** = 230Vac

Code **PH11T**Power **20W** (1 LED COB)Led color **1-2-9**Spot **B-D-F-T**Power supply **6**Finishing **A-B-M-N**

20 W/tot

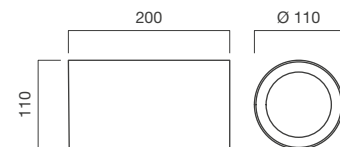
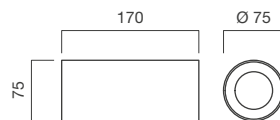

Spot

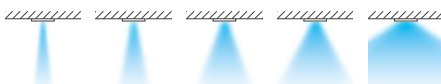

A = 15° **T** = 25° **B** = 45° **F** = 60° **D** = 120°

Finiture / Finishing

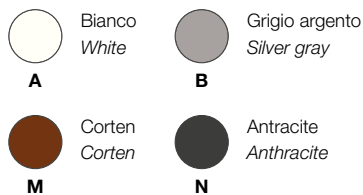

Esempio codice / Code example

PH05T10W9B6A

Diagramma a cono rilevato con LED COB, lente 45°, bianco naturale.

Cone diagram measured with natural white, COB LED, lens 45°.



Diagramma a cono rilevato con LED COB, lente 45°, bianco naturale.

Cone diagram measured with natural white, COB LED, lens 45°.



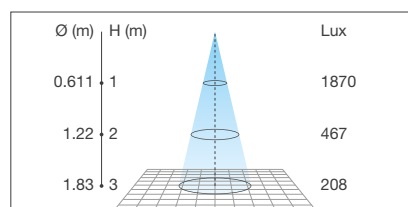
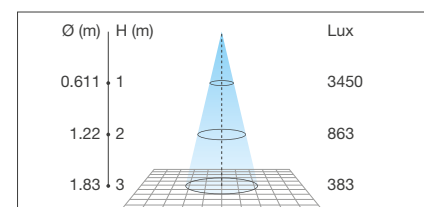

KARMA[®]
POWERLED LIGHTING



Orion

Apparecchi a LED orientabili da esterno
Adjustable LED devices for outdoor





Apparecchio compatto da 9W, orientabile per esterni.

Corpo in acciaio inox e vetro temperato.

Fissaggio con viti.

Disponibili in differenti gradazioni di lenti e con luce RGB per effetti decorativi particolari.

Utilizzabile per illuminare pareti, monumenti, edifici in genere, bordi di piscine, fontane ed altre applicazioni in ambienti molto umidi.

Led color

1 = 3000°K (741 lumen)

2 = 6000°K (849 lumen)

7 = RGB

9 = 4000°K (798 lumen)

Power supply

1 = 350mA

5 = 24Vdc

Code **OR25**

Power **9W** (3 LED HP SMD)

Led color **1-2-9**

Spot **A-B-D-F**

Power supply **5**

Finishing **L**

Code **OR25**

Power **9W** (3 LED RGB)

Led color **7**

Spot **B**

Power supply **1**

Finishing **L**

Adjustable compacted 9W power device for outdoor.

Stainless steel body, tempered glass, screw fixing.

Available in different angle of lens and with RGB light for particular decorative effects.

Suitable for wall lighting, monuments, buildings in general, poolside, fountainside, other applications in high humidity.

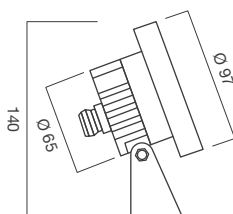

Spot

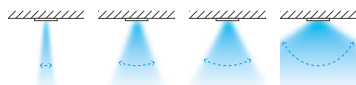

A = 15° **B** = 45° **F** = 60° **D** = 120°

Finiture / Finishing



Acciaio inox AISI304
Stainless steel AISI304

L



Code 9800416001 - Ø40 mm, H.164 mm
Picchetto per installazione a terra
opzionale su richiesta
Optional picket for installation on the
ground on request

Esempio codice / Code example

OR259W9F5L

Diagramma a cono rilevato con LED HP SMD, lente 45°, bianco caldo.

Cone diagram measured with warm white, HP SMD LED, lens 45°.

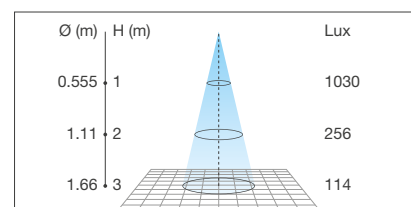



Codice accessori elettrici / *Electrical accessories code*

Power supply IP67

ALP015.24	1	ALP120.24	1 - 12
ALP030.24	1 - 3	ALP150.24	1 - 15
ALP060.24	1 - 6	ALP200.24	1 - 21

Dimmer Controller IP20

AL240P	1 - 25
AL288D/P	1 - 30
CTR112DIM	1 - 30

RGB Controller IP20

CTR031
CTR203C1W

RGB Driver IP67

DRVRGB.IP

OR25 8W



Apparecchio ad elevata potenza luminosa (18W, 27W), orientabile per esterni.

Corpo in acciaio inox e vetro temperato.

Fissaggio con viti.

Disponibili in differenti gradazioni di lenti e con luce RGB per effetti decorativi particolari.

Utilizzabile per illuminare pareti, monumenti, edifici in genere, bordi di piscine, fontane ed altre applicazioni in ambienti molto umidi.

Led color

1 = 3000°K (2223 lumen)

2 = 6000°K (2547 lumen)

7 = RGB

9 = 4000°K (2394 lumen)

Power supply

5 = 24Vdc

Code **OR26**

Power **27W** (9 LED HP SMD)

Led color **1-2-9**

Spot **B-D**

Power supply **5**

Finishing **L**

Code **OR26**

Power **18W** (6 LED RGB)

Led color **7**

Spot **B**

Power supply **5**

Finishing **L**

Adjustable high brightness device (18W, 27W) for outdoor.

Stainless steel body, tempered glass, screw fixing.

Available in different angle of lens and with RGB light for particular decorative effects.

Suitable for wall lighting, monuments, buildings in general, poolside, fountainside, other applications in high humidity.

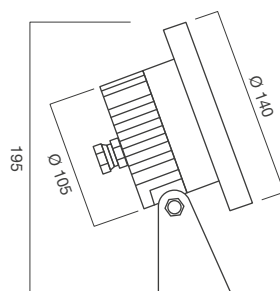

Spot

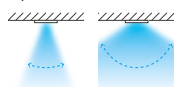

B = 45° **D** = 120°

Finiture / Finishing



Acciaio inox AISI304
Stainless steel AISI304

L



Code 9800416017 - Ø50 mm, H.250 mm
Picchetto per installazione a terra
opzionale su richiesta
Optional picket for installation on the
ground on request

Esempio codice / Code example

OR2627W2B5L

Diagramma a cono rilevato con 9 LED HP SMD, lente 45°, bianco naturale.

Cone diagram measured with natural white,
9 HP SMD LED, lens 45°.

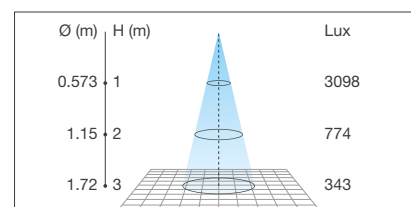



Codice accessori elettrici / *Electrical accessories code*

OR26 27W

Power supply IP67

ALP060.24	1	ALP200.24	1 - 6
ALP120.24	1 - 3		
ALP150.24	1 - 4		

Dimmer Controller IP20

AL240P	1 - 7
AL288D/P	1 - 9
CTR112DIM	1 - 9

RGB Controller IP20

CTR112RGB
CTR203CT
CTR213



KARMA[®]
POWERLED LIGHTING



Crux

Apparecchi a LED da incasso a parete per esterni
Wall LED recessed devices for outdoor



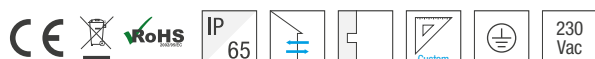

**Apparecchio da incasso a parete,
per interni ed esterni.**

Corpo in alluminio pressofuso con frontale in acciaio inox spazzolato e vetro temperato satinato. Fissaggio a vite.

Prodotto fornito di controcassa in plastica. Utilizzabile per scale, corridoi, segnapasso, indicazione di percorso, zone di passaggio.

**Recessed wall-mounted device,
for indoor and outdoor.**

Cast aluminum body with brushed stainless steel front panel and sandblasted tempered glass. Screw fixing.

Plastic recessed box included. Ideal for stairs, hallways, pathway and walkways.

Led color

- 1** = 3000°K (810 lumen)
- 2** = 6000°K (892 lumen)
- 9** = 4000°K (864 lumen)

Power supply

- 6** = 230Vac

Code **CR22N**

Power **6W** (48 LED SMD)

Led color **1-2-9**

Spot **D**

Power supply **6**

Finishing **L**



165x65 mm

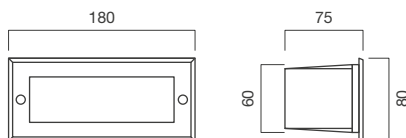

Spot



D = 120°

Finiture / Finishing



Acciaio inox
Stainless steel

L

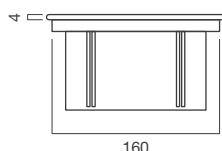

Esempio codice / Code example

CR22N6W2D6L

Code 9800500007
Controcassa in plastica
in dotazione
Plastic recessed box
included

Diagramma a cono rilevato con LED SMD,
bianco naturale, emissione 120°.
Cone diagram measured with natural white,
SMD LED, 120° emission.

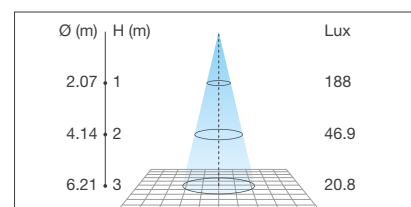





KARMA[®]
POWERLED LIGHTING



Dorado

Apparecchi a LED da incasso per interni
LED recessed devices for indoor





Apparecchio slim fisso da incasso per interni.

Corpo in alluminio con diffusore satinato per emissione omogenea della luce, oppure lenticolare per emissione spot.

Fissaggio tramite apposite alette metalliche, montabile su cartongesso sia a soffitto che a parete. Disponibile con varie gradazioni e colori.

Fixed slim recessed device for indoor.

Aluminum body, satin diffuser for homogeneous emission of light or lenticular diffuser for spot emission.

Metal mounting spring, mountable on drywall on the ceiling and on the wall. Available in many color gradations.

Led color

- 1** = 3000°K (436 lumen)
- 2** = 6000°K (499 lumen)
- 3** = Blu / Blue
- 7** = RGB
- 9** = 4000°K (469 lumen)

Power supply

- 1** = 350mA
- 5** = 24Vdc

Code	DO00N
Power	3W (3 LED HP SMD)
Led color	1-2-3-9
Spot	B-D-E-T
Power supply	5
Finishing	A-D-E-F

Code	DO00N
Power	3W (3 LED RGB)
Led color	7
Spot	D
Power supply	1
Finishing	A-D-E-F

Spot

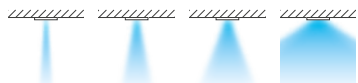

E = 10° **T** = 25° **B** = 45° **D** = 120°

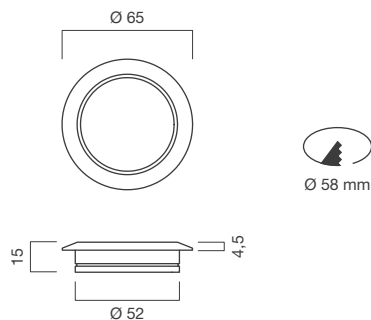

Finiture / Finishing



Bianco
White

A



Nichel spazzolato
Brushed nickel

D



Cromo
Chrome

E



Ottone
Brass

F

Esempio codice / Code example

DO00N3W3D5A

Diagramma a coni rilevato con LED HP SMD, bianco caldo, emissione 120°.

Cone diagram measured with warm white, HP SMD LED, 120° emission.

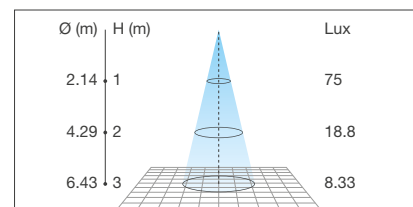



Codice accessori elettrici / *Electrical accessories code*

Power supply IP20

APT006.24	1	APPT060.24	1 - 18
APPT015.24	1 - 4		
APPT030.24	1 - 8		

Dimmer Controller IP20

AL240P	1 - 68
AL288D/P	1 - 80
CTR112DIM	1 - 80

RGB Controller IP20

CTR031	DRVRGB
CTR203C1W	

DO00N 24Vdc 3W

RGB Driver IP20



Apparecchio orientabile a sfera, da incasso per interni.

Corpo in alluminio, disponibile in varie finiture.

Fissaggio a clips, montabile sia a soffitto che a parete.

Particolare meccanismo di orientamento a sfera con effetto micro occhio di bue.

Adatto anche per applicazioni in vetrine e bacheche.

Sphere adjustable recessed device, for indoor.

Aluminum body, available in various finishes.

Clip fixing, both ceiling and wall mounting.

Specific sphere adjusting mechanism with micro bull's eye effect.

Suitable for application in cabinet and showcase.

Led color

1 = 3000°K (247 lumen)

2 = 6000°K (283 lumen)

9 = 4000°K (266 lumen)

Power supply

2 = 650mA

5 = 24Vdc

Code **DO05N**

Power **3W** (1 LED HP SMD)

Led color **1-2-9**

Spot **B-G-T**

Power supply **2-5**

Finishing **A-D**

ORIENTABILE / ADJUSTABLE

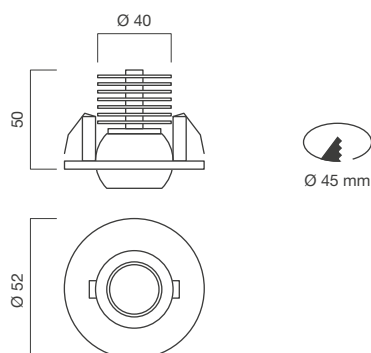

Spot

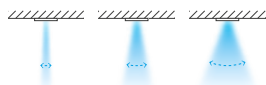

G = 8° **T** = 25° **B** = 45°

Finiture / Finishing



Esempio codice / Code example

DO05N3W9T5D

Diagramma a coni rilevato con LED HP SMD, lente 45°, bianco caldo.

Cone diagram measured with warm white, HP SMD LED, lens 45°.

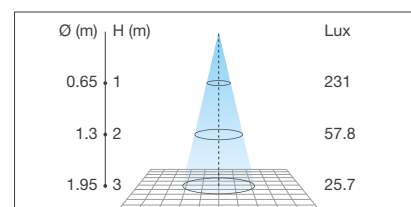



Codice accessori elettrici / *Electrical accessories code*

DO05N

Power supply IP20

24Vdc 3W		650mA 3W	
APT006.24	1	APC003.650	1
APT015.24	1 - 4	APC006.650	1 - 3
APT030.24	1 - 8	ACP01.650	1 - 4
APT060.24	1 - 18	ACP020.650	3 - 9

Dimmer Controller IP20

24Vdc 3W		650mA 3W	
AL240P	1 - 68	DCJOLLY	4 - 8
AL288D/P	1 - 80		

Driver IP20

650mA 3W	
DVR650	

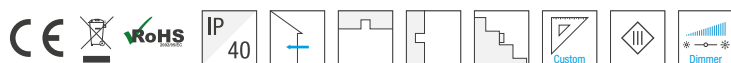

Mini apparecchio fisso per interni da incasso.

Corpo in acciaio inox, ideale per effettuare punti luce sia a soffitto che a parete, come segnapassi o per segnalare gradini.

Disponibile in varie finiture e funzionante in bassa tensione.

Mini fixed recessed device for indoor.

Stainless steel body, ideal for light point effect, on ceiling or on wall, as step signal or step light. Available in many finishes, low voltage input.

Led color

1 = 3000°K (78 lumen)

2 = 6000°K (92 lumen)

9 = 4000°K (86 lumen)

Power supply

1 = 350mA

Code **DO06N**

Power **1W** (LED Emitter)

Led color **1-2-9**

Spot **D**

Power supply **1**

Finishing **A-L**

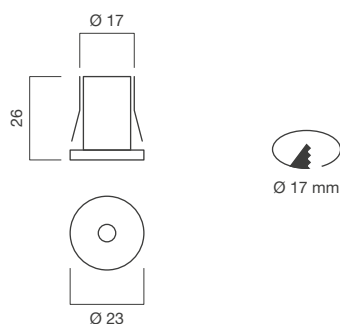

Spot



D = 120°

Finiture / Finishing



Bianco
White



Acciaio inox
Stainless steel

Esempio codice / Code example

DO06N1W2D1L

Diagramma a coni rilevato con LED Emitter, lente 120°, bianco caldo.

Cone diagram measured with warm white, Emitter LED, lens 120°.

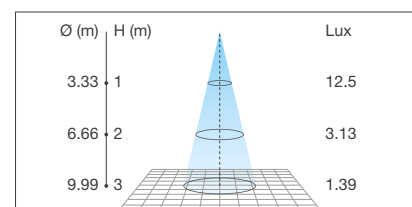



Codice accessori elettrici / *Electrical accessories code*

DO06N 1W

Power supply IP20

APP003.350	1 - 3	APC012.350	3 - 10
ACP018.350	7 - 13	APC020.350	6 - 15

Driver IP20

DVR350



KARMA[®]
POWERLED LIGHTING



Grus

Apparecchi a LED modulari, da incasso per interni
Modular recessed LED devices, for indoor



La filosofia Karma abbraccia la nuova serie Grus

In fase di rinnovamento, l'azienda Karma ha voluto superare una serie di vincoli legati ai prodotti da incasso, da interno, a soffitto o a parete. Il vecchio concetto di prodotto si evolve e diventa componibile.

Il cliente decide la sorgente luminosa e la finitura del prodotto in base ai propri gusti e alle esigenze del progetto. L'utente trova così la giusta soluzione abbinando tonalità della luce ed estetica del faro.

The Karma philosophy embraces the new Grus series

During its renovation, Karma company wants to overcome many constraints related to recessed indoor products, ceiling or wall mounted. The old concept of product evolves and becomes modular.

The customer decides the light source and finishing of the product as his taste and the requests of the project. In this way, the user finds the right solution combining light shades and light aesthetics.

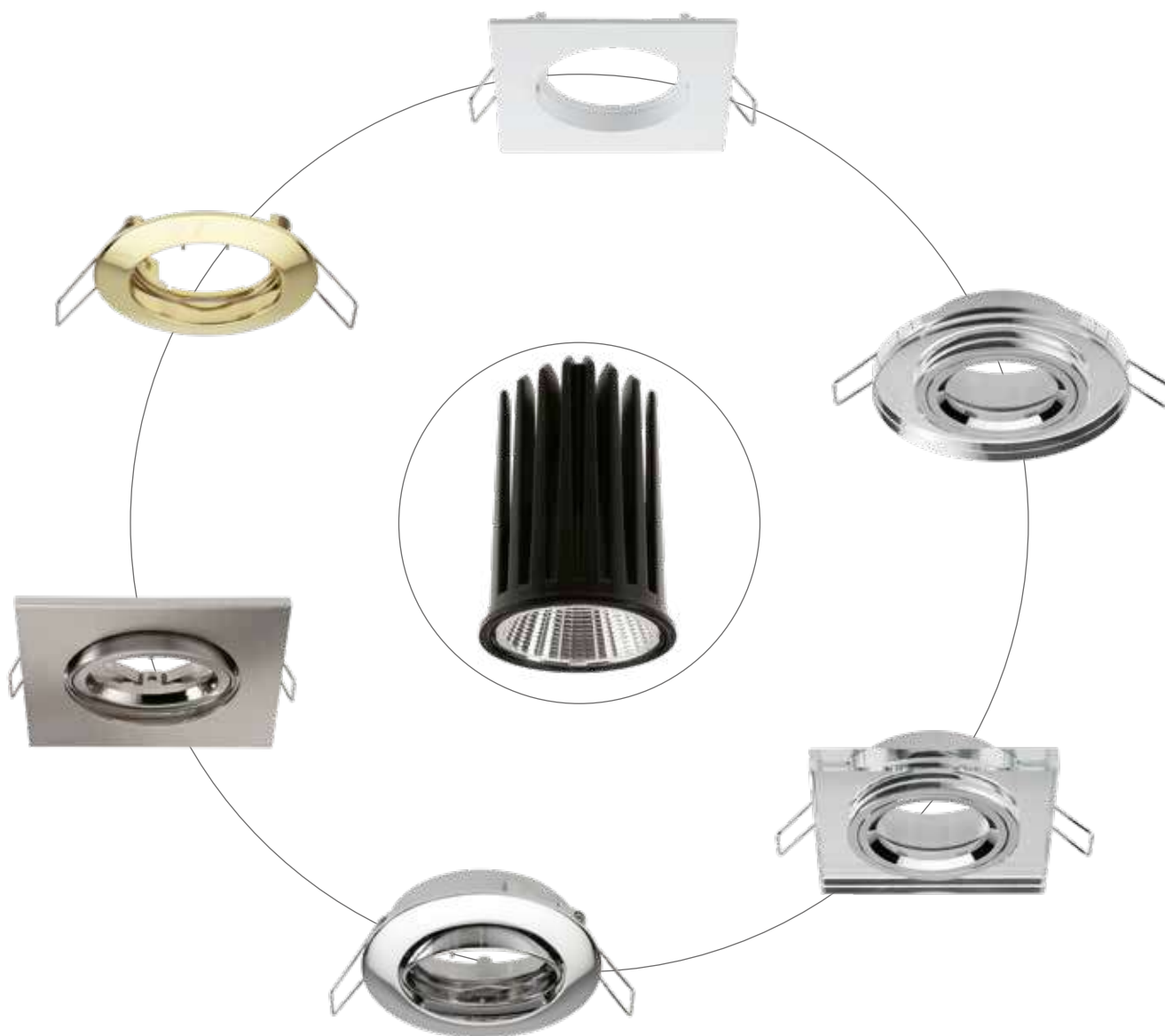

La gamma

Con i prodotti della serie Grus, Karma offre diverse tipologie di sorgente luminosa: modulo COB di potenza 9W con riflettore, modulo trittico di potenza 8W con diverse tonalità di luce bianca e diversi angoli di emissione, con alimentazione a 230Vac oppure con alimentazione a 24Vdc dimmerabile e il modulo RGB full color. Per quanto riguarda le cornici, il cliente può scegliere di avere il prodotto fisso oppure orientabile, in metallo o vetro, rotondo oppure quadrato.

The range

With the products of the Grus series, Karma company offers several types of light source: 9W power COB module with reflector, 3-LED module with 8W power with different temperature of white light and various emission angles, with 230Vac input voltage or with dimmable 24Vdc input voltage and the RGB full color module. Regarding the frames, the customer can choose to have the product fixed or rotatable, metal or glass, round or square shape.

GR210

**Apparecchio fisso da incasso per interni.**

Montaggio tramite molle su cartongesso o altri materiali, installabile sia a soffitto che a parete. Ghiera in alluminio pressofuso, in forma rotonda o quadrata, disponibili in diverse finiture. Con la possibilità di alloggiare varie tipologie di corpi illuminanti ad elevate prestazioni o RGB. Alimentabile per alcuni modelli direttamente a 230Vac, oppure a 24Vdc dimmerabile.

Fixed recessed interior device.

Spring fixing on drywall or other materials, mountable on the ceiling or on the wall. Die-cast aluminum frame, round or square, available in different finishes. With the possibility to house various models of high performance LED or RGB. For some models, plugin direct to 230Vac, or 24Vdc dimmable version.

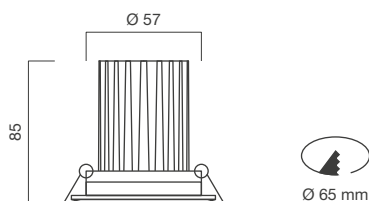
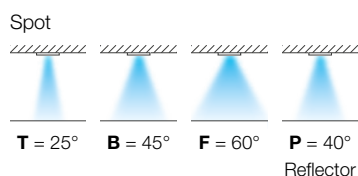
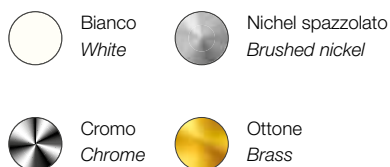

Led color	Power supply
1 = 3200°K (741 lumen)	1 = 350mA
2 = 6000°K (849 lumen)	5 = 24Vdc
7 = RGB	6 = 230Vac
9 = 4100°K (798 lumen)	

**Finitura flangia / Flange finishing**

Esempio codici ordine / Example order codes
Codice motore / Engine code

GR3039W7T1

Codice flangia / Flange code

+ GR011E

Code GR011A
Cornice tonda bianca
White round frame

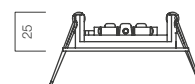

Code GR011D
Cornice tonda nichel spazzolato
Brushed nickel round frame



Code GR011E
Cornice tonda cromo
Chrome round frame

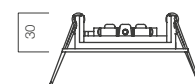

Code GR011F
Cornice tonda ottone
Brass round frame

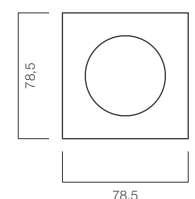

Code GR021A
Cornice quadra bianca
White square frame

Code GR021D
Cornice quadra nichel spazzolato
Brushed nickel square frame

Code	GR207
Power	8W (3 LED HP SMD)
Led color	1-2-9
Spot	B-F-T
Power supply	5-6

Code	GR303
Power	9W (3 LED RGB)
Led color	7
Spot	B-T
Power supply	1

Code	GR210
Power	9W (1 LED COB)
Led color	1-2-9
Spot	P
Power supply	6

Diagramma a cono rilevato con LED HP SMD, lente 45°, bianco caldo.
Cone diagram measured with warm white, HP SMD LED, lens 45°.





Diagramma a cono rilevato con LED COB, lente 45°, bianco naturale.
Cone diagram measured with natural white, COB LED, lens 45°.

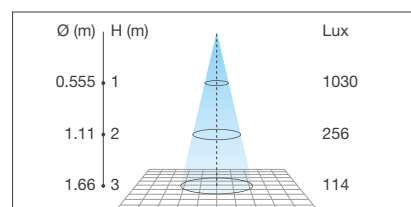
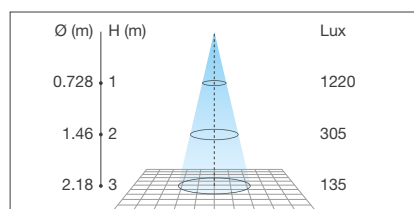

Codice accessori elettrici / Electrical accessories code

Power supply IP20

ALT015.24	1
ALT030.24	1 - 3
ALT060.24	1 - 6
ALT120.24	1 - 12
ALT150.24	1 - 15
ALT200.24	1 - 21

GR207 24Vdc 8W

Dimmer Controller IP20

AL240P	1 - 25
AL288D/P	1 - 30
CTR112DIM	1 - 30

RGB Controller IP20

CTR112RGB
CTR203CT
CTR213

GR210



Apparecchio orientabile da incasso per interni.

Montaggio tramite molle su cartongesso o altri materiali, installabile sia a soffitto che a parete. Ghiera in alluminio pressofuso, in forma rotonda o quadrata, disponibili in diverse finiture. Con la possibilità di alloggiare varie tipologie di corpi illuminanti ad elevate prestazioni o RGB. Alimentabile per alcuni modelli direttamente a 230Vac, oppure a 24Vdc dimmerabile.

Adjustable recessed interior device.

Spring fixing on drywall or other materials, mountable on the ceiling or on the wall.

Die-cast aluminum frame, round or square, available in different finishes.

With the possibility to house various models of high performance LED or RGB.

For some models, plugin direct to 230Vac, or 24Vdc dimmable version.



Code GR012A
Cornice tonda bianca
White round frame

Code GR012D
Cornice tonda
nichel spazzolato
*Brushed nickel
round frame*

Code GR012E
Cornice tonda cromo
Chrome round frame

Code GR012F
Cornice tonda ottone
Brass round frame

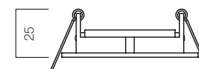

Code GR022A
Cornice quadra bianca
White square frame

Code GR022D
Cornice quadra
nichel spazzolato
*Brushed nickel
square frame*

Code GR022E
Cornice quadra cromo
Brass square frame

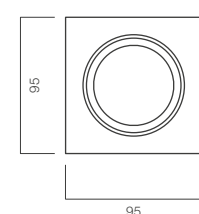
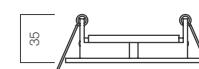

Led color
1 = 3200°K (741 lumen)
2 = 6000°K (849 lumen)
7 = RGB
9 = 4100°K (798 lumen)

Power supply
1 = 350mA
5 = 24Vdc
6 = 230Vac

Code	GR207
Power	8W (3 LED HP SMD)
Led color	1-2-9
Spot	B-F-T
Power supply	5-6

Code	GR303
Power	9W (3 LED RGB)
Led color	7
Spot	B-T
Power supply	1

Code	GR210
Power	9W (1 LED COB)
Led color	1-2-9
Spot	P
Power supply	6

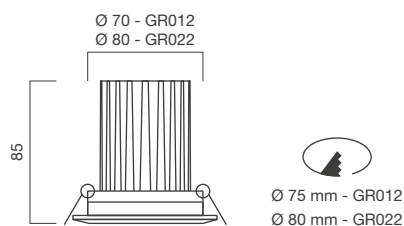
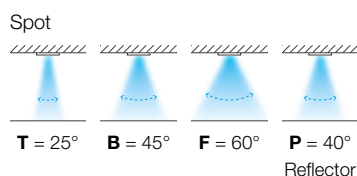

Finitura flangia / Flange finishing



Esempio codici ordine / Example order codes
Codice motore / Engine code

GR2078W2B5

Codice flangia / Flange code

+ **GR022D**

Diagramma a cono rilevato con LED HP SMD, lente 45°, bianco caldo.
Cone diagram measured with warm white, HP SMD LED, lens 45°.





Diagramma a cono rilevato con LED COB, lente 45°, bianco naturale.
Cone diagram measured with natural white, COB LED, lens 45°.

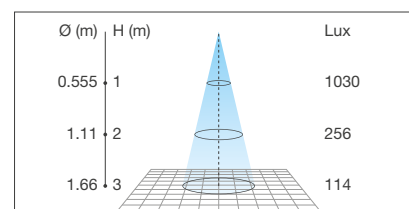
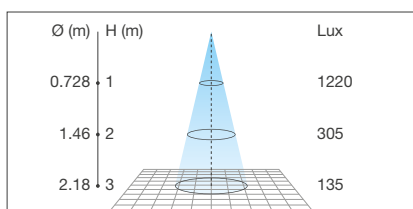

Codice accessori elettrici / Electrical accessories code

Power supply IP20

ALT015.24	1
ALT030.24	1 - 3
ALT060.24	1 - 6
ALT120.24	1 - 12
ALT150.24	1 - 15
ALT200.24	1 - 21

GR207 24Vdc 8W

Dimmer Controller IP20

AL240P	1 - 25
AL288D/P	1 - 30
CTR112DIM	1 - 30

RGB Controller IP20

CTR112RGB
CTR203CT
CTR213

GR210

**Apparecchio fisso da incasso per interni.**

Montaggio tramite molle su cartongesso o altri materiali, installabile sia a soffitto che a parete. Ghiera in alluminio e vetro, disponibile in forma rotonda o quadrata.

Faretto particolarmente elegante, adatto per stanze da bagno, specchiere o parti comuni di casa.

Con la possibilità di alloggiare varie tipologie di corpi illuminanti ad elevate prestazioni o RGB. Alimentabile per alcuni modelli direttamente a 230Vac, oppure a 24Vdc dimmerabile.

Fixed recessed interior device.

Spring fixing on drywall or other materials, mountable on the ceiling or on the wall.

Die-cast aluminum and glass frame, round or square shape.

Particularly elegant spotlight, suitable for bathrooms, mirrors or home common ambients.

With the possibility to house various models of high performance LED or RGB.

For some models, plugin direct to 230Vac, or 24Vdc dimmable version.

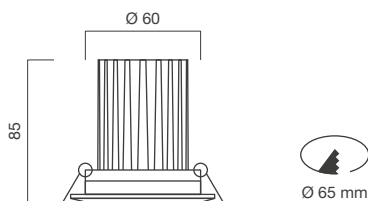
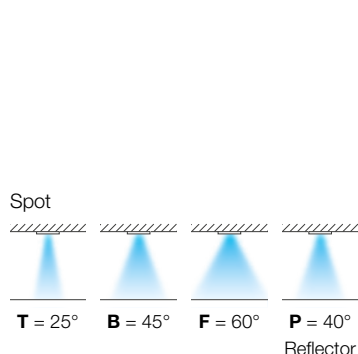

Led color	Power supply
1 = 3200°K (741 lumen)	1 = 350mA
2 = 6000°K (849 lumen)	5 = 24Vdc
7 = RGB	6 = 230Vac
9 = 4100°K (798 lumen)	

**Finitura flangia / Flange finishing****Esempio codici ordine / Example order codes**

Codice motore / Engine code

GR2109W9P6

Codice flangia / Flange code

+ **GR019T**

Code GR018T
Cornice tonda di vetro
effetto specchio
Glass round frame,
mirror effect

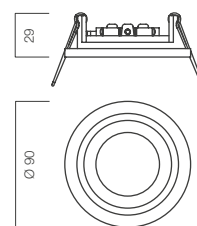

Code GR019T
Cornice quadra di vetro
effetto specchio
Glass square frame,
mirror effect

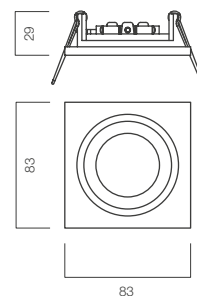

Code	GR207
Power	8W (3 LED HP SMD)
Led color	1-2-9
Spot	B-F-T
Power supply	5-6

Code	GR303
Power	9W (3 LED RGB)
Led color	7
Spot	B-T
Power supply	1

Code	GR210
Power	9W (1 LED COB)
Led color	1-2-9
Spot	P
Power supply	6

Diagramma a cono rilevato con LED HP SMD, lente 45°, bianco caldo.

Cone diagram measured with warm white, HP SMD LED, lens 45°.





Diagramma a cono rilevato con LED COB, lente 45°, bianco naturale.
Cone diagram measured with natural white, COB LED, lens 45°.

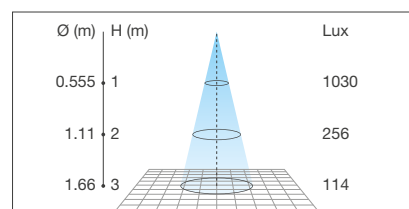
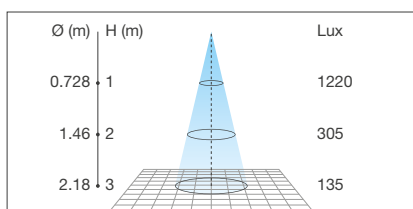

Codice accessori elettrici / Electrical accessories code

Power supply IP20

ALT015.24	1
ALT030.24	1 - 3
ALT060.24	1 - 6
ALT120.24	1 - 12
ALT150.24	1 - 15
ALT200.24	1 - 21

GR207 24Vdc 8W

Dimmer Controller IP20

AL240P	1 - 25
AL288D/P	1 - 30
CTR112DIM	1 - 30

RGB Controller IP20

CTR112RGB
CTR203CT
CTR213



KARMA[®]
POWERLED LIGHTING



Lira

Apparecchi a LED da incasso per interni
LED recessed devices for indoor



La filosofia Karma abbraccia la nuova serie Lira

L'idea delle flange intercambiabili si estende anche alla serie Lira.

Con questa linea di prodotti il cliente ha a disposizione due misure e due potenze, entrambe dotate di COB e riflettore.

Una volta definita la fonte luminosa, l'utente ha la possibilità di scegliere la finitura del prodotto in base ai gusti o all'esigenza del progetto.

Viene offerta così la giusta soluzione abbinando dimensioni e potenza del prodotto, con l'estetica del faro.

The Karma philosophy embraces the new Lira series

The concept of interchangeable frames also extends to the Lira series.

With this serie of product, the customer has available two products with different dimensions and powers, each one equipped with COB and reflector.

Once the light source is defined, the user can choose the finishing of the product according to the taste or the need of the project.

The right solution is offered by matching the size and power of the product with the aesthetics of the device.

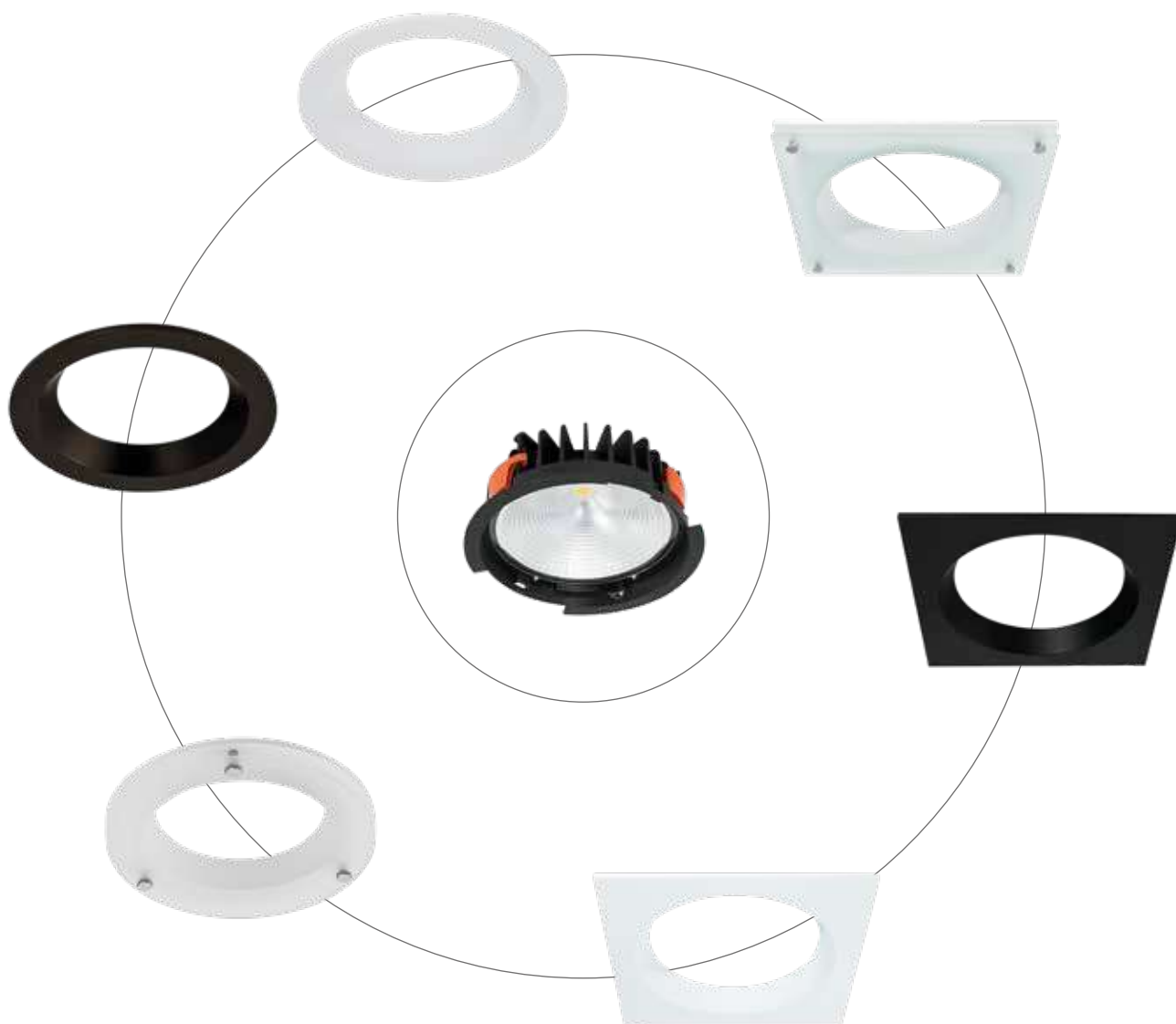

La gamma

Con i prodotti della serie Lira, Karma offre due diversi motori, equipaggiati con mono LED COB di potenza 15W o 30W.

Per quanto riguarda l'estetica, il cliente può scegliere di avere il prodotto con varie cornici intercambiabili. Con un semplice movimento ad incasso, il cliente ha la possibilità di cambiare l'aspetto del faretto, abbinandolo alle diverse ambientazioni.

The range

With the Lira Series products, Karma offers two different module, equipped with mono LED COBs, 15W or 30W power.

With regard to esthetic, the customer may choose to have the product with various interchangeable frames. With simple recessed movement, the customer has the option to change the appearance of the device, combining it with different location.

LI11N

**Apparecchio fisso da incasso per interni.**

Equipaggiato con COB di potenza 15W per 175 mm di diametro, montaggio tramite speciali alette con tiraggio a vite, su cartongesso o altri materiali, installabile sia a soffitto che a parete.

Corpo in alluminio pressofuso e ghiera frontale in alluminio di forma rotonda, disponibile in finitura verniciata bianco, nero o bianco con vetro.

Viene dato in dotazione l'apposito filtro satinato per ottenere un fascio luminoso più ampio. Ideale per illuminare ambienti domestici, particolarmente indicato per negozi ed aree espositive.

Fixed recessed interior device.

Equipped with 15W COB LED, 175 mm diameter, mounting by special adjustable springs by screwdrivers, on drywall or other materials, mountable on the ceiling or on the wall.

Die-cast aluminum body and round aluminum frame, available in white and black painted finish or white painted finish with glass.

A special satin-type filter is provided to get a wider light beam.

Ideal for indoor environments, especially for shops and exhibition areas.



Code LI11NRA
Flangia tonda bianca
White round flange

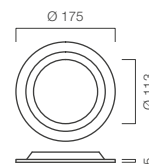

Code LI11NRC
Flangia tonda nera
Black round flange

Code LI11NRTA
Flangia tonda vetro su bianco
White round flange with glass

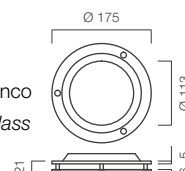

Led color

1 = 3000°K (1498 lumen)

9 = 4000°K (1575 lumen)

Power supply

6 = 230Vac

Code	LI11N
Power	15W (1 LED COB)
Led color	1-9
Spot	F
Power supply	6

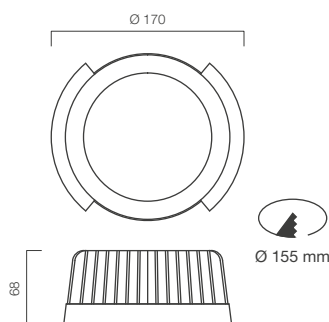

Spot



F = 60°

Finitura flangia / Flange finishing



Bianco
White



Nero
Black



Vetro satinato
Satin glass

Esempio codici ordine / Example order codes

Codice motore / Engine code

Codice flangia / Flange code

LI11N15W1F6

+ LI11NRC

Code 9800405005

Filtro satinato in dotazione, permette di aumentare il fascio luminoso a 90°
Satin-type filter allows to get a light beam at 90°



90°

Diagramma a cono rilevato con LED COB, lente 60°, bianco caldo.

Cone diagram measured with warm white, COB LED, lens 60°.

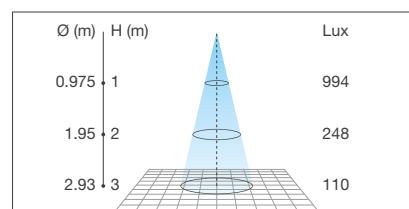



LI13N

**Apparecchio fisso da incasso per interni.**

Equipaggiato con COB di potenza 30W per 230 mm di diametro, montaggio tramite speciali alette con tiraggio a vite, su cartongesso o altri materiali, installabile sia a soffitto che a parete.

Corpo in alluminio pressofuso e ghiera frontale in alluminio di forma rotonda o quadrata, disponibile in finitura verniciata bianco, nero o bianco con vetro.

Viene dato in dotazione l'apposito filtro satinato per ottenere un fascio luminoso più ampio. Ideale per illuminare ambienti domestici, particolarmente indicato per negozi ed aree espositive.

Fixed recessed interior device.

Equipped with 30W COB LED, 230 mm diameter, mounting by special adjustable springs by screwdrivers, on drywall or other materials, mountable on the ceiling or on the wall.

Die-cast aluminum body and round or square aluminum frame, available in white and black painted finish or white painted finish with glass.

A special satin-type filter is provided to get a wider light beam.

Ideal for indoor environments, especially for shops and exhibition areas.

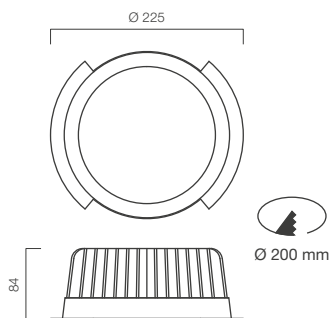

Spot



F = 60°

Finitura flangia / Flange finishing

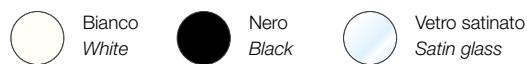

Esempio codici ordine / Example order codes

Codice motore / Engine code Codice flangia / Flange code

LI13N30W9F6 + **LI13NSTA**

Code LI13NRA

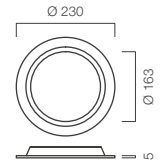
Flangia tonda bianca
White round flange

Code LI13NRC

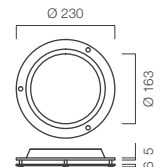
Flangia tonda nera
Black round flange

Code LI13NRTA

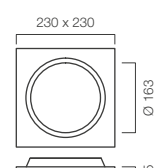
Flangia tonda vetro su bianco
White round flange with glass

Code LI13NSA

Flangia quadrata bianca
White square flange

Code LI13NSC

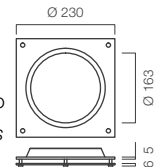
Flangia quadrata nera
Black square flange

Code LI13NSTA

Flangia quadrata vetro su bianco
White square flange with glass

Led color

1 = 3000°K (3096 lumen)**9** = 4000°K (3150 lumen)

Power supply

6 = 230VacCode **LI13N**Power **30W** (1 LED COB)Led color **1-9**Spot **F**Power supply **6**

Diagramma a cono rilevato con LED COB, lente 60°, bianco caldo.
Cone diagram measured with warm white, COB LED, lens 60°.

Code 9800405006
Filtro satinato in dotazione, permette di aumentare il fascio luminoso a 90°
Satin-type filter allows to get a light beam at 90°

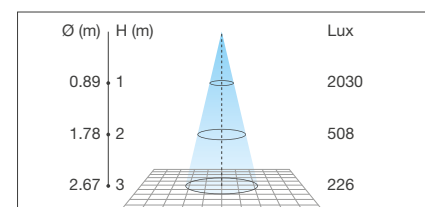





KARMA[®]
POWERLED LIGHTING



Pegasus

Proiettori a LED da interno per aree espositive,
su sistema binario 3 circuiti 230Vac
*LED devices indoor for exhibition areas,
on track system 3 circuits 230Vac*



PE46



PE47

**Proiettori orientabili ad alta potenza.**

Corpo in alluminio in diverse finiture, con adattatore per installazione a binario alimentato a 230Vac a 3 circuiti per ottenere una doppia accensione, possibilità di montaggio a soffitto con apposito accessorio KT1016.

Equipaggiati con LED COB di diverse potenze (10W, 20W, 30W) e prestazioni per un medesimo stile di prodotto.

Ideale per illuminazione di negozi, vetrine, espositori ed interni in genere.

Led color

1 = 3000°K (1031 lumen)**2** = 6000°K (1062 lumen)**9** = 4000°K (1050 lumen)

Power supply

6 = 230VacCode **PE46**Power **10W** (1 LED COB)Led color **1-2-9**Spot **A-B-T**Power supply **6**Finishing **A-B-C**

20 W/tot

Led color

1 = 3000°K (2017 lumen)**2** = 6000°K (2068 lumen)**9** = 4000°K (2036 lumen)

Power supply

6 = 230VacCode **PE47**Power **20W** (1 LED COB)Led color **1-2-9**Spot **B-F-T**Power supply **6**Finishing **A-B-C****Adjustable hi power spotlight.**

Aluminum body in different color of finishing, with adapter for installation on 3 circuit tracks with 230Vac power supply to get a double switch, possibility to ceiling mounting with accessory code KT1016.

Equipped with different power COB LED (10W, 20W, 30W) and performances, for the same style of product.

Ideal for the lighting of shops, shop windows, stands, and interior space in general.

Spot

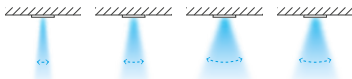
**A** = 15° **T** = 25° **B** = 45° **F** = 60°

Finiture / Finishing



Esempio codice / Code example

PE4720W9F6C

Diagramma a cono rilevato con LED COB, lente 45°, bianco naturale.

Cone diagram measured with natural white, COB LED, lens 45°.

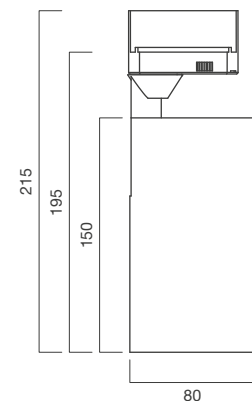
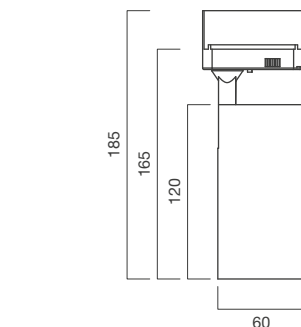

Diagramma a cono rilevato con LED COB, lente 45°, bianco naturale.

Cone diagram measured with natural white, COB LED, lens 45°.

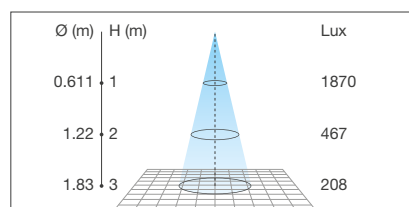
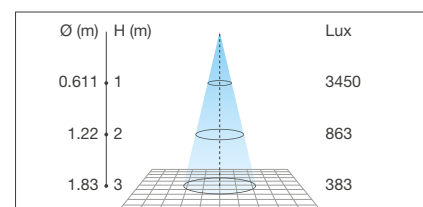

PE48

Pegasus



30
W/tot

Led color
1 = 3000°K (3096 lumen)
2 = 6000°K (3192 lumen)
9 = 4000°K (3150 lumen)

Power supply
6 = 230Vac

Code	PE48
Power	30W (1 LED COB)
Led color	1-2-9
Spot	A-T
Power supply	6
Finishing	A-B-C



Diagramma a cono rilevato con LED COB, lente 45°, bianco naturale.
Cone diagram measured with natural white, COB LED, lens 45°.



Sistema track per serie Pegasus a tre circuiti con doppia accensione.

Track system for Pegasus series three circuits with double switch.

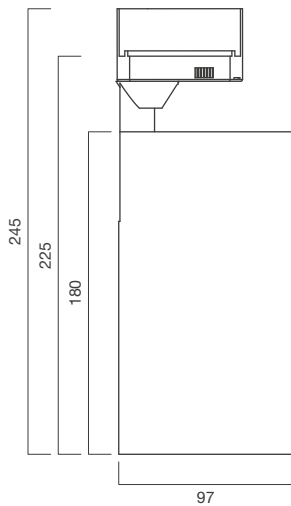
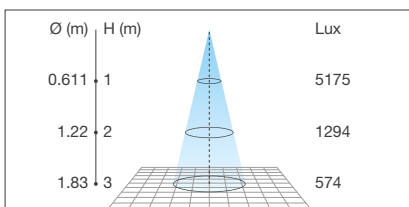
Binario a 3 circuiti
3 circuit track

Power supply
250V, 16A

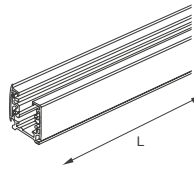

Code	Finishing	L = mm
KT1001W	Bianco / White	1000
KT1001G	Grigio / Gray	1000
KT1001N	Nero / Black	1000
KT1002W	Bianco / White	2000
KT1002G	Grigio / Gray	2000
KT1002N	Nero / Black	2000
KT1003W	Bianco / White	3000
KT1003G	Grigio / Gray	3000
KT1003N	Nero / Black	3000

Miniconnettore lineare
Linear miniconnector

Power supply
250V, 16A

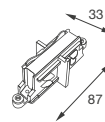

Code	Finishing
KT1004W	Bianco / White
KT1004G	Grigio / Gray
KT1004N	Nero / Black

Inseritore di tensione DX
DX input voltage

Power supply
250V, 16A

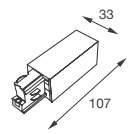

Code	Finishing
KT1005W	Bianco / White
KT1005G	Grigio / Gray
KT1005N	Nero / Black

Inseritore di tensione SX
SX input voltage

Power supply
250V, 16A

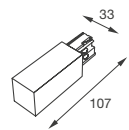

Code	Finishing
KT1006W	Bianco / White
KT1006G	Grigio / Gray
KT1006N	Nero / Black

Connettore a croce
Cross connector

Power supply
250V, 16A

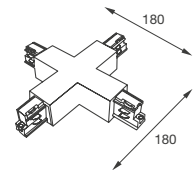

Code	Finishing
KT1011W	Bianco / White
KT1011G	Grigio / Gray
KT1011N	Nero / Black

ESEMPIO DI COLLEGAMENTO / EXAMPLE OF CONNECTION

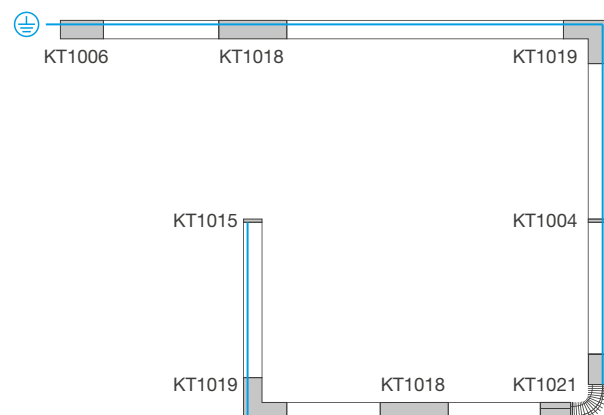
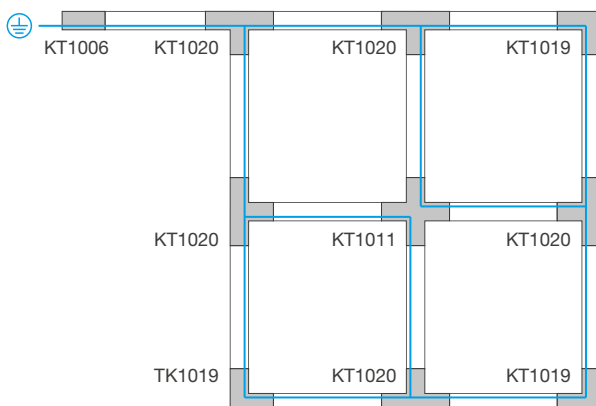

Kit sospensione
con cavo
*Suspension kit
with cable*

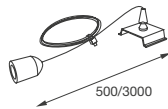

Adattatore binario 3 circuiti
Adaptor 3 circuit track

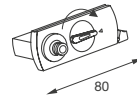

Power supply
250V, 16A

Connettore a T reversibile
T connector reversible

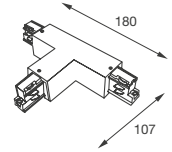

Power supply
250V, 16A

Code	Finishing	L = mm
KT1014W	Bianco / <i>White</i>	500/3000
KT1014G	Grigio / <i>Gray</i>	500/3000
KT1014N	Nero / <i>Black</i>	500/3000

Code	Finishing
KT1017W	Bianco / <i>White</i>
KT1017G	Grigio / <i>Gray</i>
KT1017N	Nero / <i>Black</i>

Code	Finishing
KT1020W	Bianco / <i>White</i>
KT1020G	Grigio / <i>Gray</i>
KT1020N	Nero / <i>Black</i>

Tappo chiusura binario
Cup/plug to close track

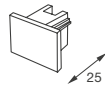

Connettore lineare
Linear connector

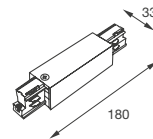

Power supply
250V, 16A

Connettore flessibile
Flexible connector

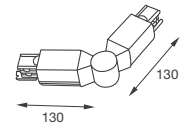

Power supply
250V, 16A

Code	Finishing
KT1015W	Bianco / <i>White</i>
KT1015G	Grigio / <i>Gray</i>
KT1015N	Nero / <i>Black</i>

Code	Finishing
KT1018W	Bianco / <i>White</i>
KT1018G	Grigio / <i>Gray</i>
KT1018N	Nero / <i>Black</i>

Code	Finishing
KT1021W	Bianco / <i>White</i>
KT1021G	Grigio / <i>Gray</i>
KT1021N	Nero / <i>Black</i>

Adattatore montaggio
plafoniera
*Ceiling assembling
adaptor*

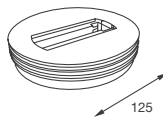

Connettore a L per angolo
a 90° reversibile
*L connector for 90° angle
reversible*

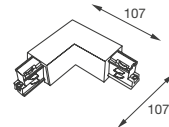

Power supply
250V, 16A

Miniconnettore lineare
non elettrificato
*Linear miniconnector
not electrified*

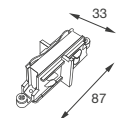

Code	Finishing
KT1016W	Bianco / <i>White</i>
KT1016G	Grigio / <i>Gray</i>
KT1016N	Nero / <i>Black</i>

Code	Finishing
KT1019W	Bianco / <i>White</i>
KT1019G	Grigio / <i>Gray</i>
KT1019N	Nero / <i>Black</i>

Code	Finishing
KT1022W	Bianco / <i>White</i>
KT1022G	Grigio / <i>Gray</i>
KT1022N	Nero / <i>Black</i>

DISTANZE TRA I FORI DEL BINARIO E CAPACITÀ DI CARICO / *DISTANCES BETWEEN TRACK HOLES AND LOADING CAPACITY*

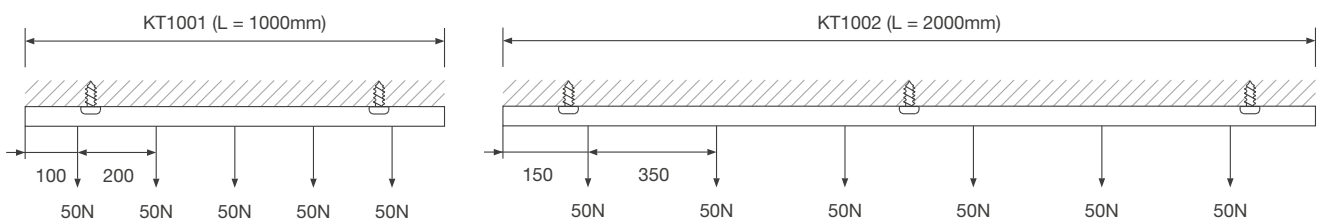



KARMA[®]
POWERLED LIGHTING



Antares

Apparecchi a LED da incasso per interni ed esterni
LED recessed devices for indoor and outdoor



AN02N

AN04N

**Apparecchio da incasso, per interni ed esterni.**

Corpo in alluminio anodizzato nero, frontale in alluminio di forma rotonda (AN02N) oppure quadrata (AN04N) in diverse finiture. Lente frontale in plastica, con varie gradazioni ottiche. Disponibile con luce in diverse tonalità di bianco, blu oppure in versione RGB. Fissaggio a clips per incasso su cartongesso. Su richiesta disponibile controcassa per fissaggio a muro. Di dimensioni compatte, installabile nelle docce, nei corridoi e come segnapasso su percorsi pedonali.

Recessed device for indoor and outdoor.

Black anodized aluminum body, round (AN02N) or square (AN04N) aluminum front in different finishes. Plastic front lens, with various optical gradations. Available in different white color of temperature, blue or in RGB version. Mounting clip for fixing on plasterboard. By request, plastic recessed box is available. Compact size, can be installed on showers and corridors and as step signal on footpaths.

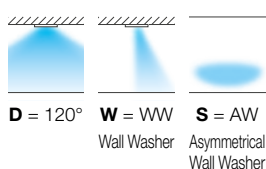
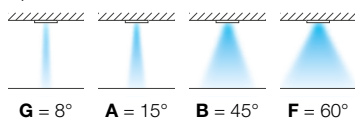
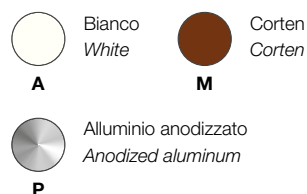
Spot**Finiture / Finishing****Led color**

- 1** = 3000°K (247 lumen)
- 2** = 6000°K (283 lumen)
- 3** = Blu / Blue
- 7** = RGB
- 9** = 4000°K (266 lumen)

Power supply

- 1** = 350mA
- 2** = 650mA
- 5** = 24Vdc

Code	AN02N ○ AN04N □
Power	3W (1 LED HP SMD)
Led color	1-2-3-9
Spot	A-B-D-F-G-S-W
Power supply	2-5
Finishing	A-M-P

Code	AN02N ○ AN04N □
Power	3W (1 LED RGB)
Led color	7
Spot	B
Power supply	1
Finishing	A-M-P



Diagramma a cono rilevato con LED HP SMD, lente 45°, bianco caldo.

Cone diagram measured with warm white, HP SMD LED, lens 45°.



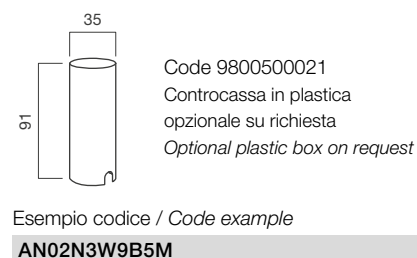
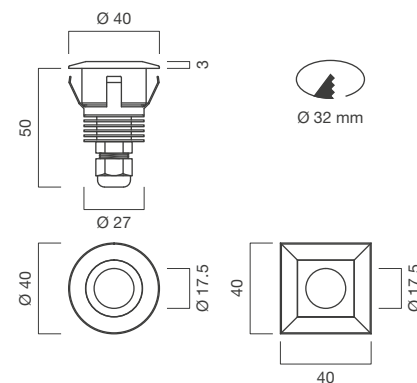
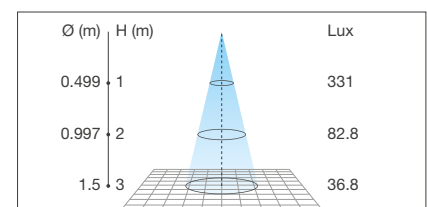

Codice accessori elettrici / Electrical accessories code

AN02N AN04N

Power supply IP67

24Vdc 3W		650mA 3W	
APP009.24	1 - 2	APP003.650	1
ALP015.24	1 - 4	APP006.650	1 - 2
ALP030.24	1 - 8		
ALP060.24	1 - 18		
ALP120.24	1 - 34		
ALP150.24	1 - 40		
ALP200.24	1 - 55		

Dimmer Controller IP20

24Vdc 3W	
AL240P	1 - 68
AL288D/P	1 - 80
CTR112DIM	1 - 80

RGB Controller IP20

350mA RGB	
CTR031	
CTR203C1W	

RGB Driver/Driver IP67

350mA RGB	650mA 3W
DRVRGB.IP	DVR650.IP

AN12N

AN13N



Mini apparecchio da incasso per esterno in acciaio.

Corpo in acciaio inox tornito e frontale in acciaio inox. Fissaggio con apposita clip per incasso a parete o con apposita controcassa per pareti o pavimenti in cemento.

Illuminazione diffusa per mezzo di vetrino opalino. Utilizzabile per aree verdi, bordo fontane, bordo piscine, indicatore di percorsi, segnapassi, per docce e scale esterne o percorsi calpestabili.

Mini recessed stainless steel luminaire for outdoor.

Stainless steel turned body and stainless steel front. Clip fastening for wall recessed mounting or dedicated recessed box for cement walls and floors.

Diffuse light thanks to a opaline glass.

Usable in green areas, fountain edges, pool edges, footpaths indicator, step signal for showers and external stairs.

Led color

9 = 4000°K (157 lumen)

Power supply

1 = 350mA

5 = 24Vdc

Code	AN12N <input type="radio"/> AN13N <input type="checkbox"/>
Power	1W (1 LED HP SMD)
Led color	9
Spot	D
Power supply	1-5
Finishing	L

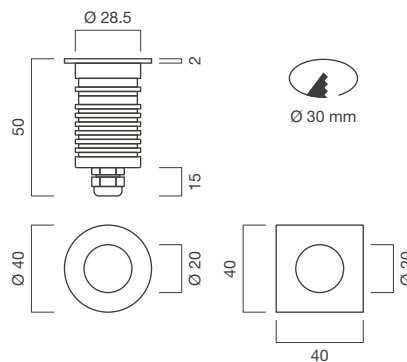

Spot



D = 120°

Finiture / Finishing



Acciaio inox AISI304
Stainless steel AISI304

L

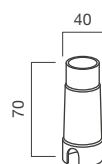

Code BOXAN12/13/35/36N
Controcassa in plastica
in dotazione
Plastic recessed box
included

Esempio codice / Code example

AN12N1W9D5L

Diagramma a cono rilevato con LED HP SMD, bianco naturale, emissione 120°.

Cone diagram measured with natural white, HP SMD LED, 120° emission.

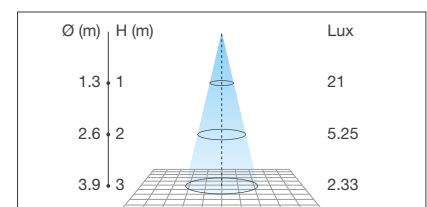



Codice accessori elettrici / *Electrical accessories code*

AN12N AN13N

Power supply IP67

24Vdc 1W		350mA 1W	
ALP015.24	1 - 12	APP003.350	1 - 3
ALP030.24	1 - 25	APP006.350	2 - 6
ALP060.24	1 - 50	ACP018.350	7 - 13
ALP120.24	1 - 100		
ALP150.24	1 - 127		

Dimmer Controller IP20

24Vdc 1W	
AL240P	1 - 200
AL288D/P	1 - 244

Driver IP20

350mA 1W	
DVR350	

AN14N

AN15N



Apparecchio da incasso per interno wall washer.

Originale apparecchio in alluminio verniciato a mono emissione laterale.
Estremamente compatto e di design particolare questo faretto permette di creare delle illuminazioni wall washer senza vedere la fonte luminosa e senza notare la dimensione dell'apparecchio.
Può essere montato in varie direzioni per effettuare effetti decorativi.
Estetica creata da noto architetto Italiano.

Recessed wall washer luminaire for indoor.

*Original luminaire in painted aluminum with lateran unique emission.
Extremely compact and with a particular design.
This spotlight permits to obtain wall washer lightings without see the light emitting source and without notice the device's sizes.
Can be mounted in many directions to do various decorative effects.
Design created by a famous italian architect.*

Led color
1 = 3000°K (165 lumen)

Power supply
5 = 24Vdc
7 = 500mA

Code	AN14N <input type="radio"/> AN15N <input type="checkbox"/>
Power	2W (1 LED HP SMD)
Led color	1
Spot	D
Power supply	5-7
Finishing	A

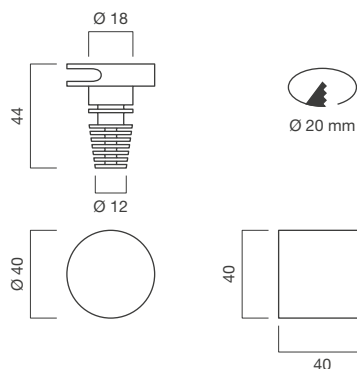

Spot



D = 120°

Finiture / Finishing

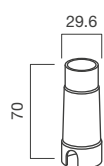

Code BOXAN14/15N
Controcassa in plastica
in dotazione
Plastic recessed box
included

Esempio codice / Code example

AN15N2W1D5A

Codice accessori elettrici / Electrical accessories code

Power supply IP20

24Vdc 2W		500mA 2W	
APT006.24	1 - 2	APP003.500	1 - 2
APT015.24	1 - 6	APC006.500	2 - 4
APT030.24	1 - 12	APC012.500	2 - 7
APT060.24	1 - 24	APC020.500	4 - 10

Dimmer Controller IP20

24Vdc 2W		500mA 2W	
AL240P	1 - 100	AL240P + DRV500	1 - 10
AL288D/P	1 - 122		

Driver IP20

500mA 2W

DVR500

Diagramma a cono rilevato con LED HP SMD,
bianco caldo, emissione 120°.

*Cone diagram measured with warm white,
HP SMD LED, 120° emission.*

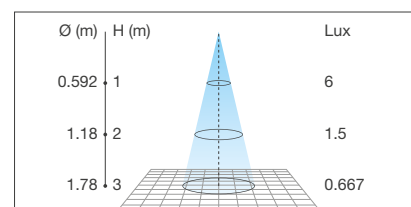

AN35N

AN36N

Antares



Apparecchio mini spot da incasso per uso interno.

Originale mini spot a scomparsa filo muro in alluminio verniciato.

Costruito per generare illuminazione di cortesia ma con effetto filo muro.

Utilizzabile a soffitto e parete per scale, corridoi aree di passaggio e soffitti di stanze con controsoffitto.

Disponibile una controcassa specifica per installazione su murature piene.

Recessed mini spot luminaire for indoor.

Original mini spot with hidden flush-mounting effect in painted aluminum.

Built to create courtesy lighting with wall-flush effect.

Usable in ceilings, stair's wall, corridors, passing areas and ceilings of room with countertop.

Available a dedicated mounting box to install it in solid walls.

Led color

1 = 3000°K (146 lumen)

Power supply

1 = 350mA

5 = 24Vdc

Code **AN35N** **AN36N**

Power **1W** (1 LED HP SMD)

Led color **1**

Spot **L**

Power supply **1-5**

Finishing **A**

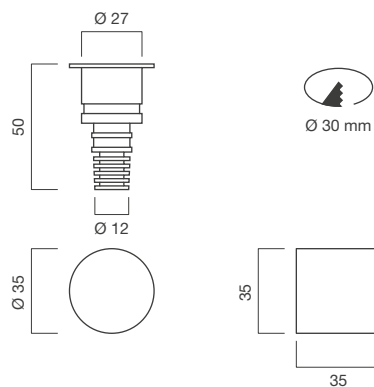

Spot



L = 75°

Finiture / Finishing

Bianco
White

A

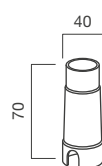

Code BOXAN12/13/35/36N
Controcassa in plastica
in dotazione
Plastic recessed box
included

Esempio codice / Code example

AN35N1W1L5A



Codice accessori elettrici / Electrical accessories code

Power supply IP20

24Vdc 1W	350mA 1W
APT006.24 1 - 5	APP003.350 1 - 3
APT015.24 1 - 12	APP006.350 2 - 6
APT030.24 1 - 25	
APT060.24 1 - 50	

Dimmer Controller IP20

24Vdc 1W	350mA 1W
AL240P 1 - 200	AL240P + DRV350 1 - 20
AL288D/P 1 - 2 44	

Driver IP20

350mA 1W

DVR350

Diagramma a cono rilevato con LED HP SMD, lente 75°, bianco caldo.

Cone diagram measured with warm white, HP SMD LED, lens 75°.

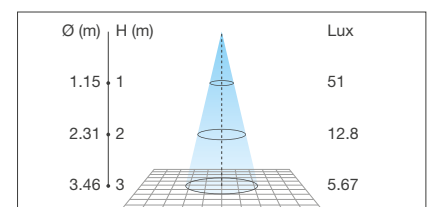

AN38N

AN39N



Mini apparecchio da incasso per esterno in acciaio.

Corpo in acciaio inox tornito e frontale in acciaio inox. Fissaggio mediante O ring per incasso a parete o con apposita controcassa per pareti o pavimenti in cemento. Illuminazione ordinabile con varie gradazioni per mezzo di apposite lenti. Utilizzabile per aree verdi, bordo fontane, bordo piscine, indicatore di percorsi, segnapassi, per docce e scale esterne o percorsi carrabili. Disponibile inoltre una controcassa maggiorata per effettuare collegamenti in serie di parecchi faretti. Ordinabile a luce blu per effetti decorativi particolari. Costruzione robusta per applicazioni gravose.

Stainless steel mini recessed luminaire for outdoor.

Stainless steel turned body and stainless steel front. Fastening through O-ring for recessed mounting or with specific box for wall or cement floor. Orderable many light gradation with apposite lens. Usable in green areas, fountain edges, pool edges, footpaths indicator, step signal for showers and external stairs. Available a bigger recessed box to connect many device serially. Blu light available for particular decorative effects. Strong building for heavy applications.

Spot

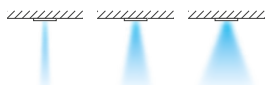

G = 8° T = 25° B = 45°

Finiture / Finishing

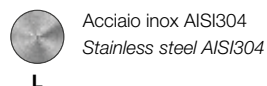

Led color

- 1 = 3000°K (247 lumen)
- 2 = 6000°K (283 lumen)
- 3 = Blu / Blue
- 9 = 4000°K (266 lumen)

Power supply

- 2 = 650mA
- 5 = 24Vdc

Code	AN38N ○ AN39N □
Power	3W (1 LED HP SMD)
Led color	1-2-3-9
Spot	B-G-T
Power supply	2-5
Finishing	L

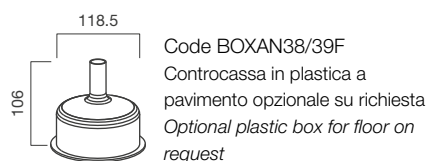
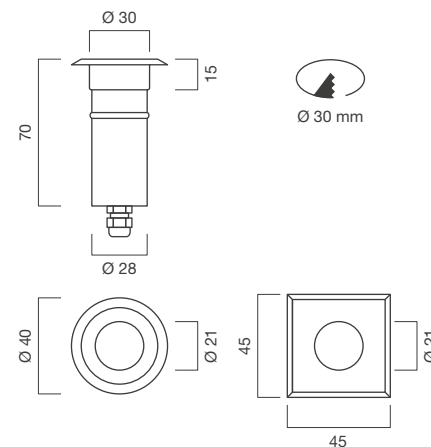

Esempio codice / Code example

AN39N3W3B5L



Diagramma a cono rilevato con LED HP SMD, lente 45°, bianco caldo.
Cone diagram measured with warm white, HP SMD LED, lens 45°.

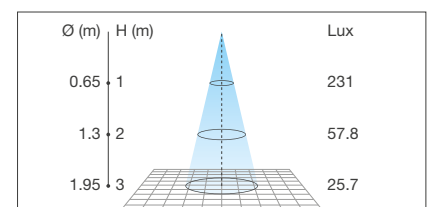



Codice accessori elettrici / *Electrical accessories code*

AN38N AN39N

Power supply IP67

24Vdc 3W		650mA 3W	
APP009.24	1 - 2	APP003.650	1
ALP015.24	1 - 4	APP006.650	1 - 2
ALP030.24	1 - 8		
ALP060.24	1 - 18		
ALP120.24	1 - 34		
ALP150.24	1 - 40		
ALP200.24	1 - 55		

Dimmer Controller IP20

24Vdc 3W		650mA 3W	
AL240P	1 - 68	AL240P + DRV650	1 - 68
AL288D/P	1 - 80		

Driver IP20

650mA 3W
DVR650.IP



KARMA[®]
POWERLED LIGHTING



Scorpius

Apparecchi a LED da incasso per interni ed esterni
LED recessed devices for indoor and outdoor





Per la versione a 24Vdc, il prodotto viene corredato di un driver sul cavo di alimentazione.
For the 24Vdc version, the product is equipped with a driver on the input wire.



Apparecchio da incasso per interni ed esterni.

Corpo in alluminio anodizzato nero, frontale in alluminio di forma rotonda (SC02R) oppure quadrata (SC02S) in diverse finiture. Lente frontale in plastica, con varie gradazioni ottiche. Disponibile con luce in diverse tonalità di bianco oppure in versione RGB. Fissaggio a clips per incasso su cartongesso. Su richiesta disponibile controcassa per fissaggio a muro. Di dimensioni compatte, installabile su docce e corridoi e come segnapasso su percorsi pedonali.

Led color

- 1** = 3000°K (247 lumen)
- 2** = 6000°K (283 lumen)
- 3** = Blu / Blue
- 7** = RGB
- 9** = 4000°K (266 lumen)

Power supply

- 1** = 350mA
- 2** = 650mA
- 5** = 24Vdc

Code	SC02R ○ SC02S □
Power	3W (1 LED HP SMD)
Led color	1-2-3-9
Spot	A-B-D-F-G-S-W
Power supply	2-5
Finishing	A-D-E-M-P

Code	SC02R ○ SC02S □
Power	3W (1 LED RGB)
Led color	7
Spot	B
Power supply	1
Finishing	A-D-E-M-P

Recessed device for indoor and outdoor.

Black anodized aluminum body, round (SC02R) or square (SC02S) aluminum front in different finishes. Plastic front lens, with various optical gradations. Available in different white color of temperature or in RGB version. Mounting clip for fixing on plasterboard. By request, plastic recessed box is available.

Compact size, can be installed on showers and corridors and as step signal on footpaths.

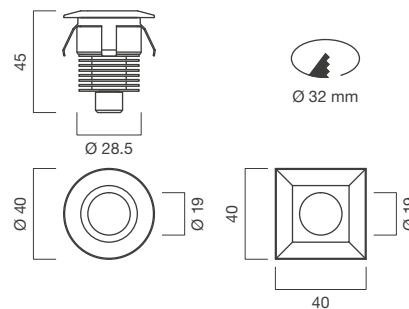

Spot

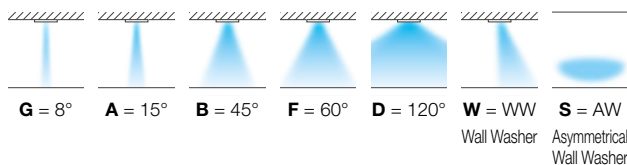

Finiture / Finishing

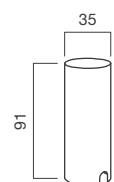
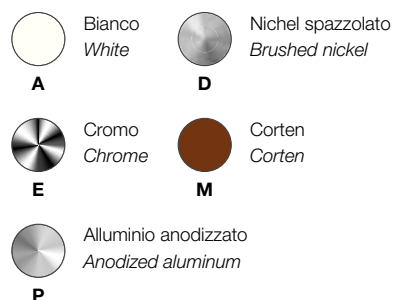

Code 9800500021
Controcassa in plastica
opzionale su richiesta
Optional plastic box on request

Esempio codice / Code example

SC02R3W9B5M

Diagramma a cono rilevato con LED HP SMD, lente 45°, bianco caldo.
Cone diagram measured with warm white, HP SMD LED, lens 45°.

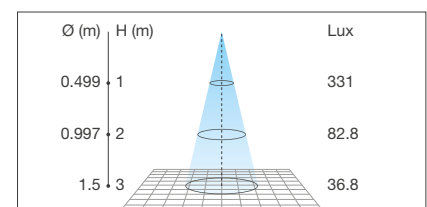



Codice accessori elettrici / *Electrical accessories code*

SC02

Power supply IP67

24Vdc 3W		650mA 3W	
APP009.24	1 - 2	APP003.650	1
ALP015.24	1 - 4	APP006.650	1 - 2
ALP030.24	1 - 8		
ALP060.24	1 - 18		
ALP120.24	1 - 34		
ALP150.24	1 - 40		
ALP200.24	1 - 55		

Dimmer Controller IP20

24Vdc 3W	
AL240P	1 - 68
AL288D/P	1 - 80
CTR112DIM	1 - 80

RGB Controller IP20

350mA RGB	
CTR031	
CTR203C1W	

RGB Driver/Driver IP67

350mA RGB	650mA 3W
DRVRGB.IP	DVR650.IP



Per la versione a 24Vdc, il prodotto viene corredato di un driver sul cavo di alimentazione.
For the 24Vdc version, the product is equipped with a driver on the input wire.

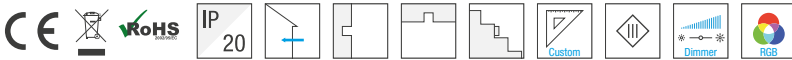

Apparecchio da incasso per interni.

Corpo in alluminio anodizzato nero, frontale in alluminio di forma rotonda (SC16R) oppure quadrata (SC16S) in diverse finiture.

LED frontale a vista per emissione ad ampio raggio.

Disponibile con luce in diverse tonalità di bianco oppure in versione RGB.

Fissaggio a clips per incasso su cartongesso.

Su richiesta disponibile controcassa per fissaggio a muro.

Di dimensioni compatte, ideale per installazioni a parete come indicatore di percorsi.

Recessed device for indoor.

Black anodized aluminum body, round (SC16R) or square (SC16S) aluminum front in different finishes.

Without lens to have wide emission of light.

Available in different white color of temperature or in RGB version.

Mounting clip for fixing on plasterboard.

By request, plastic recessed box is available.

Compact size, ideal for installation on wall as signal on paths.

Spot



D = 120°

Finiture / Finishing



Led color

- 1** = 3000°K (218 lumen)
- 2** = 6000°K (241 lumen)
- 7** = RGB
- 9** = 4000°K (229 lumen)

Power supply

- 1** = 350mA
- 2** = 650mA
- 5** = 24Vdc

Code **SC16R** **SC16S**

Power **3W** (1 LED HP SMD)

Led color **1-2-9**

Spot **D**

Power supply **2-5**

Finishing **A-E-P**

Code **SC16R** **SC16S**

Power **3W** (1 LED RGB)

Led color **7**

Spot **D**

Power supply **1**

Finishing **A-E-P**

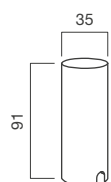
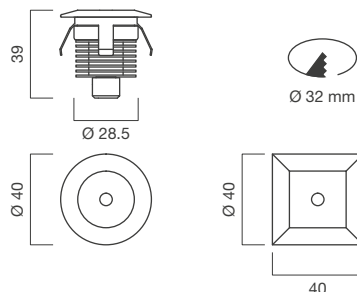

Code 9800500021
Controcassa in plastica
opzionale su richiesta
Optional plastic box on request

Esempio codice / Code example

SC16S3W7D1E

Codice accessori elettrici / Electrical accessories code

Power supply IP20

24Vdc 3W		650mA 3W	
APT006.24	1	APC006.650	1 - 3
APT015.24	1 - 4	ACP012.650	1 - 4
APT030.24	1 - 8	ACP020.650	3 - 9
APT060.24	1 - 18		

Dimmer Controller IP20

24Vdc 3W	
AL240P	1 - 68
AL288D/P	1 - 80
CTR112DIM	1 - 80

RGB Controller IP20

350mA RGB	
CTR031	
CTR203C1W	

RGB Driver/Driver IP67

350mA RGB	650mA 3W
DRVRGB	DVR650



Diagramma a coni rilevato con LED HP SMD, lente 120°, bianco caldo.

Cone diagram measured with warm white, HP SMD LED, lens 120°.

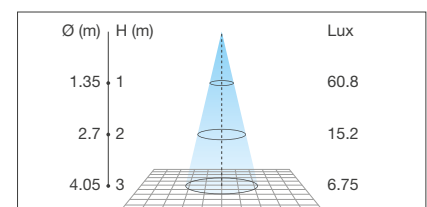



Per la versione a 24Vdc, il prodotto viene corredato di un driver sul cavo di alimentazione.
For the 24Vdc version, the product is equipped with a driver on the input wire.



Apparecchio da incasso per interni ed esterni.

Corpo in alluminio anodizzato nero, frontale in plex di forma rotonda (SC17R) oppure quadrata (SC17S) per emissione diffusa della luce.

Disponibile con luce in diverse tonalità di bianco oppure in versione RGB.

Fissaggio a clips per incasso su cartongesso.

Su richiesta disponibile controcassa per fissaggio a muro.

Di dimensioni compatte, installabile su docce e corridoi e come segnapasso su percorsi pedonali.

Recessed device for indoor and outdoor.

Black anodized aluminum body, round (SC17R) or square (SC17S) plexiglass cover, for diffused emission of light.

Available in different white color of temperature or in RGB version.

Mounting clip for fixing on plasterboard.

By request, plastic recessed box is available.

Compact size, can be installed on showers and corridors and as step signal on footpaths.

Led color	Power supply
1 = 3000°K (218 lumen)	1 = 350mA
2 = 6000°K (241 lumen)	2 = 650mA
7 = RGB	5 = 24Vdc
9 = 4000°K (229 lumen)	

Code	SC17R <input type="radio"/> SC17S <input type="checkbox"/>
Power	3W (1 LED HP SMD)
Led color	1-2-9
Spot	D
Power supply	2-5
Finishing	X

Code	SC17R <input type="radio"/> SC17S <input type="checkbox"/>
Power	3W (1 LED RGB)
Led color	7
Spot	D
Power supply	1
Finishing	X

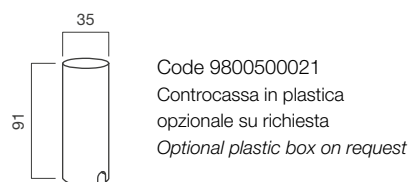
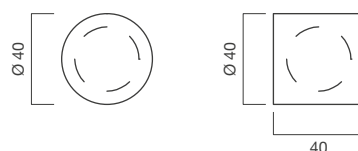
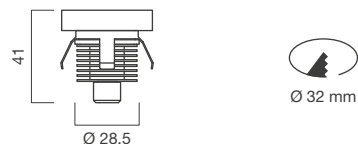

Esempio codice / Code example

SC17S3W2D2X

Codice accessori elettrici / Electrical accessories code

Power supply IP67

24Vdc 3W	650mA 3W
APP009.24	1 - 2 APP003.650 1
ALP015.24	1 - 4 APP006.650 1 - 2
ALP030.24	1 - 8
ALP060.24	1 - 18
ALP120.24	1 - 34
ALP150.24	1 - 40
ALP200.24	1 - 55

Dimmer Controller IP20

24Vdc 3W	
AL240P	1 - 68
AL288D/P	1 - 80
CTR112DIM	1 - 80

RGB Controller IP20

350mA RGB
CTR031
CTR203C1W

RGB Driver/Driver IP67

350mA RGB	650mA 3W
DRVRGB.IP	DVR650.IP



Diagramma a cono rilevato con LED HP SMD, bianco caldo, emissione 120°.

Cone diagram measured with warm white, HP SMD LED, 120° emission.

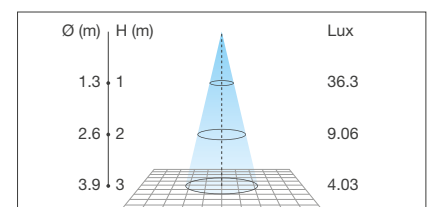

Spot



D = 120°

Finiture / Finishing



Plex
Plex

X



Per la versione a 24Vdc, il prodotto viene corredato di un driver sul cavo di alimentazione.
For the 24Vdc version, the product is equipped with a driver on the input wire.



Apparecchio da incasso per interni ed esterni.

Corpo in alluminio anodizzato nero, frontale in alluminio di forma rotonda (SC18R) oppure quadrata (SC18S) in diverse finiture, emissione side emitter monolaterale.

Disponibile con luce in diverse tonalità di bianco oppure in versione RGB.

Fissaggio a clips per incasso su cartongesso.

Su richiesta disponibile controcassa per fissaggio a muro.

Di dimensioni compatte, ideale per installazioni a parete e per creare effetti luminosi.

Recessed device for indoor and outdoor.

Black anodized aluminum body, round (SC18R) or square (SC18S) aluminum front in different finishes, single light beam side emitter effect.

Available in different white color of temperature or in RGB version.

Mounting clip for fixing on plasterboard.

By request, plastic recessed box is available.

Compact size, ideal for installation on wall to obtain lighting effects.

Led color Power supply

- 1 = 3000°K (218 lumen) 1 = 350mA
2 = 6000°K (241 lumen) 2 = 650mA
7 = RGB 5 = 24Vdc
9 = 4000°K (229 lumen)

Code	SC18R <input type="checkbox"/> SC18S <input type="checkbox"/>
Power	3W (1 LED Side Emitter)
Led color	1-2-9
Spot	C
Power supply	2-5
Finishing	D-E-M-P

Code	SC18R <input type="checkbox"/> SC18S <input type="checkbox"/>
Power	3W (1 LED RGB)
Led color	7
Spot	C
Power supply	1
Finishing	D-E-M-P

Codice accessori elettrici / Electrical accessories code

Power supply IP67

24Vdc 3W	650mA 3W
APP009.24	1 - 2 APP003.650 1
ALP015.24	1 - 4 APP006.650 1 - 2
ALP030.24	1 - 8
ALP060.24	1 - 18
ALP120.24	1 - 34
ALP150.24	1 - 40
ALP200.24	1 - 55

Dimmer Controller IP20

24Vdc 3W	
AL240P	1 - 68
AL288D/P	1 - 80
CTR112DIM	1 - 80

RGB Controller IP20

350mA RGB
CTR031
CTR203C1W

RGB Driver/Driver IP67

350mA RGB	650mA 3W
DRVRGB.IP	DVR650.IP

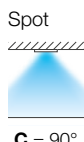

C = 90°

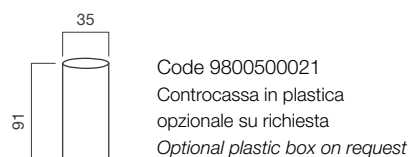
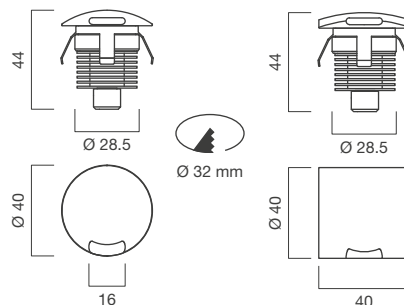

Esempio codice / Code example

SC18R3W9C5M

Code 9800500021
Controcassa in plastica
opzionale su richiesta
Optional plastic box on request



Diagramma a cono rilevato con LED Side Emitter, bianco naturale, emissione 90°.

Cone diagram measured with natural white, Side Emitter LED, 90° emission.

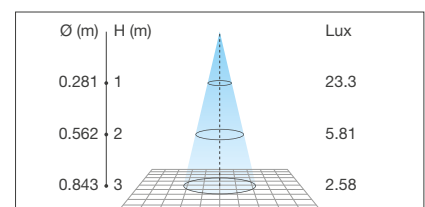

Finiture / Finishing

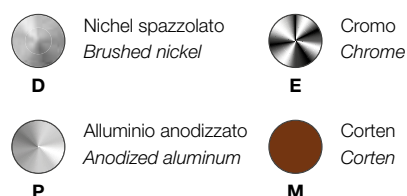



Per la versione a 24Vdc, il prodotto viene corredato di un driver sul cavo di alimentazione.
For the 24Vdc version, the product is equipped with a driver on the input wire.



Apparecchio da incasso per interni ed esterni.

Corpo in alluminio anodizzato nero, frontale in alluminio di forma rotonda (SC19R) oppure quadrata (SC19S) in diverse finiture, emissione side emitter bilaterale.

Disponibile con luce in diverse tonalità di bianco oppure in versione RGB.

Fissaggio a clips per incasso su cartongesso.

Su richiesta disponibile controcassa per fissaggio a muro.

Di dimensioni compatte, ideale per installazioni a parete e per creare effetti luminosi.

Recessed device for indoor and outdoor.

Black anodized aluminum body, round (SC19R) or square (SC19S) aluminum front in different finishes, double light beam side emitter effect. Available in different white color of temperature or in RGB version.

Mounting clip for fixing on plasterboard.

By request, plastic recessed box is available.

Compact size, ideal for installation on wall to obtain lighting effects.

By request, plastic recessed box is available.

Compact size, ideal for installation on wall to obtain lighting effects.

Spot



C = 90°

Finiture / Finishing



Nichel spazzolato
Brushed nickel

D



Cromo
Chrome

E



Alluminio anodizzato
Anodized aluminum

P



Corten
Corten

M

Led color	Power supply
1 = 3000°K (218 lumen)	1 = 350mA
2 = 6000°K (241 lumen)	2 = 650mA
7 = RGB	5 = 24Vdc
9 = 4000°K (229 lumen)	

Code	SC19R <input type="checkbox"/> SC19S <input type="checkbox"/>
Power	3W (1 LED Side Emitter)
Led color	1-2-9
Spot	C
Power supply	2-5
Finishing	D-E-M-P

Code	SC19R <input type="checkbox"/> SC19S <input type="checkbox"/>
Power	3W (1 LED RGB)
Led color	7
Spot	C
Power supply	1
Finishing	D-E-M-P

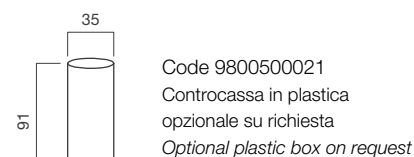
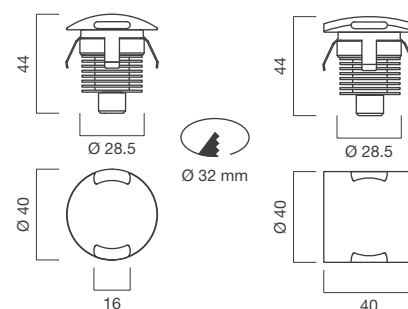

Code 9800500021
Controcassa in plastica
opzionale su richiesta
Optional plastic box on request

Esempio codice / Code example

SC19S3W7C1D

Codice accessori elettrici / Electrical accessories code

Power supply IP67

24Vdc 3W	650mA 3W
APP009.24	1 - 2 APP003.650 1
ALP015.24	1 - 4 APP006.650 1 - 2
ALP030.24	1 - 8
ALP060.24	1 - 18
ALP120.24	1 - 34
ALP150.24	1 - 40
ALP200.24	1 - 55

Dimmer Controller IP20

24Vdc 3W	
AL240P	1 - 68
AL288D/P	1 - 80
CTR112DIM	1 - 80

RGB Controller IP20

350mA RGB
CTR031
CTR203C1W

RGB Driver/Driver IP67

350mA RGB	650mA 3W
DRVRGB.IP	DVR650.IP



Diagramma a coni rilevato con LED Side Emitter, bianco naturale, emissione 90°.

Cone diagram measured with natural white, Side Emitter LED, 90° emission.

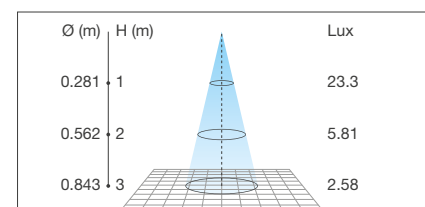



Per la versione a 24Vdc, il prodotto viene corredato di un driver sul cavo di alimentazione.
For the 24Vdc version, the product is equipped with a driver on the input wire.

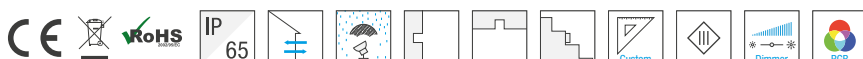

Apparecchio da incasso per interni ed esterni.

Corpo in alluminio anodizzato nero, frontale in alluminio di forma rotonda in diverse finiture.

Lente frontale in plastica, emissione di luce asimmetrica.

Disponibile con luce in diverse tonalità di bianco oppure in versione RGB.

Fissaggio a clips per incasso su cartongesso.

Su richiesta disponibile controcassa per fissaggio a muro.

Di dimensioni compatte, installabile su scale, corridoi e come segnapasso su percorsi pedonali.

Recessed device for indoor and outdoor.

Black anodized aluminum body, round aluminum front in different finishes.

Plastic lens, asymmetrical emission of light.

Available in different white color of temperature or in RGB version.

Mounting clip for fixing on plasterboard.

By request, plastic recessed box is available.

Compact size, can be installed on stairs, corridors and as step signal on footpaths.

Spot



C = 90°

Finiture / Finishing



Nichel spazzolato
Brushed nickel

D



Cromo
Chrome

E



Alluminio anodizzato
Anodized aluminum

P

Led color	Power supply
1 = 3000°K (247 lumen)	1 = 350mA
2 = 6000°K (283 lumen)	2 = 650mA
3 = Blu / Blue	5 = 24Vdc
7 = RGB	
9 = 4000°K (266 lumen)	

Code	SC20
Power	3W (1 LED HP SMD)
Led color	1-2-3-9
Spot	C
Power supply	2-5
Finishing	D-E-P

Code	SC20
Power	3W (1 LED RGB)
Led color	7
Spot	C
Power supply	1
Finishing	D-E-P

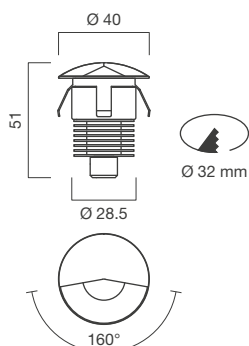

Code 9800500021
Controcassa in plastica
opzionale su richiesta
Optional plastic box on request

Esempio codice / Code example

SC203W1C5E

Codice accessori elettrici / Electrical accessories code

Power supply IP67			
24Vdc 3W		650mA 3W	
APP009.24	1 - 2	APP003.650	1
ALP015.24	1 - 4	APP006.650	1 - 2
ALP030.24	1 - 8		
ALP060.24	1 - 18		
ALP120.24	1 - 34		
ALP150.24	1 - 40		
ALP200.24	1 - 55		

Dimmer Controller IP20

24Vdc 3W	
AL240P	1 - 68
AL288D/P	1 - 80
CTR112DIM	1 - 80

RGB Controller IP20

350mA RGB	
CTR031	
CTR203C1W	

RGB Driver/Driver IP67

350mA RGB	650mA 3W
DRVRGB.IP	DVR650.IP



Diagramma a coni rilevato con LED Side Emitter, lente 90°, bianco caldo.

Cone diagram measured with warm white, Side Emitter LED, lens 90°.

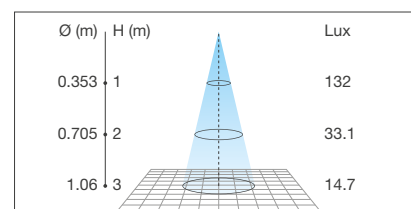



Per la versione a 24Vdc, il prodotto viene corredato di un driver sul cavo di alimentazione.
For the 24Vdc version, the product is equipped with a driver on the input wire.

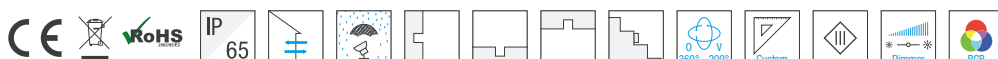

Proiettore orientabile per interni ed esterni.

Corpo completo in alluminio in diverse finiture. Lente frontale in plastica, con varie gradazioni ottiche. Disponibile con luce in diverse tonalità di bianco oppure in versione RGB. Fissaggio con staffa. Di dimensioni compatte, ideale per l'illuminazione di teche, piccole vetrine e piante.

Adjustable spotlight for indoor and outdoor.

Aluminum body in different finishes. Plastic front lens, with various optical gradations. Available in different white color of temperature or in RGB version. Fixing with bracket. Compact size, ideal for cases, small shop windows and garden plants.

Led color

- 1** = 3200°K (247 lumen)
- 2** = 6000°K (283 lumen)
- 3** = Blu / Blue
- 6** = 2700°K (234 lumen)
- 7** = RGB
- 9** = 4100°K (266 lumen)

Power supply

- 1** = 350mA
- 2** = 650mA

Codice accessori elettrici / Electrical accessories code

Power supply IP67

24Vdc 3W	650mA 3W
APP009.24	1 - 2 APP003.650 1
ALP015.24	1 - 4 APP006.650 1 - 2
ALP030.24	1 - 8
ALP060.24	1 - 18
ALP120.24	1 - 34
ALP150.24	1 - 40
ALP200.24	1 - 55

Dimmer Controller IP20

24Vdc 3W

AL240P	1 - 68
AL288D/P	1 - 80
CTR112DIM	1 - 80

RGB Controller IP20

350mA RGB

CTR031	
CTR203C1W	

RGB Driver/Driver IP67

350mA RGB	650mA 3W
DRVRGB.IP	DVR650.IP

Code	SG01
Power	3W (1 LED HP SMD)
Led color	1-2-3-6-9
Spot	A-B-F-G
Power supply	2
Finishing	C-E-P

Code	SG01
Power	3W (1 LED RGB)
Led color	7
Spot	B
Power supply	1
Finishing	C-E-P

Spot

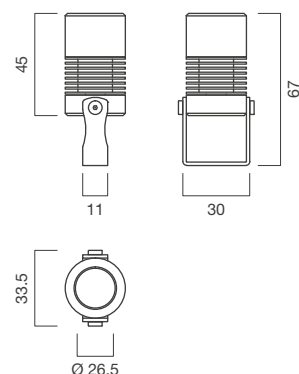
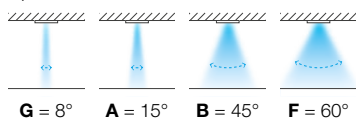

Finiture / Finishing

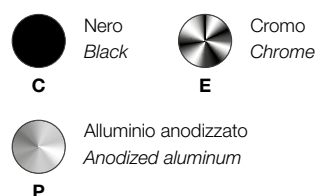

Esempio codice / Code example

SG013W7B1E

Diagramma a cono rilevato con LED HP SMD, lente 45°, bianco caldo.
Cone diagram measured with warm white, HP SMD LED, lens 45°.

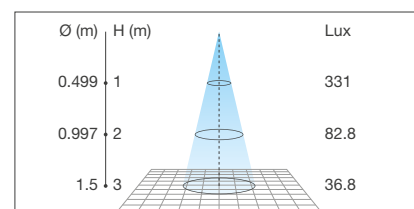



KARMA[®]
POWERLED LIGHTING



Delphinus

Apparecchi a LED da parete per interni
Wall LED devices for indoor



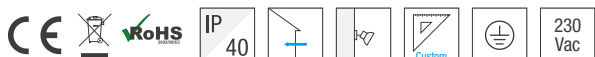

Testaletto con braccio flessibile, senza interruttore.

Punto luce LED per lettura, versione con base rotonda (DE02R) oppure quadrata (DE02S) in diverse finiture. Emissione a 45° per ottenere un effetto di luce accentata.

Lunghezza braccio 350 mm, Ø 8 mm.

Fissaggio a parete tramite apposita staffa (in dotazione). Alimentazione a 230Vac.

Bedlight with flexible arm, without switch button.

LED point light source for reading, round base (DE02R) or square base (DE02S) in different finishes. Emission at 45° to have accent lighting.

Length of arm 350 mm, Ø 8 mm.

Fixing at wall with special bracket (supplied).

Input voltage 230Vac.

Led color

1 = 3000°K (165 lumen)

Power supply

6 = 230Vac

Code

DE02R **DE02S**

Power

2W (1 LED HP SMD)

Led color

1

Spot

B

Power supply

6

Finishing

A-D-E

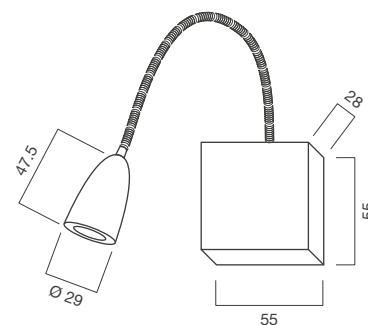
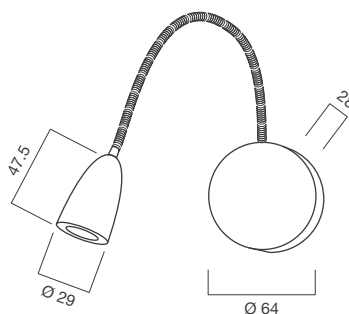

Spot



B = 45°

Finiture / Finishing



Bianco
White

A



Nichel spazzolato
Brushed nickel

D



Cromo
Chrome

E

Esempio codice / Code example

DE02S2W1B6D

Diagramma a cono rilevato con LED HP SMD, lente 45°, bianco caldo.

Cone diagram measured with warm white, HP SMD LED, lens 45°.

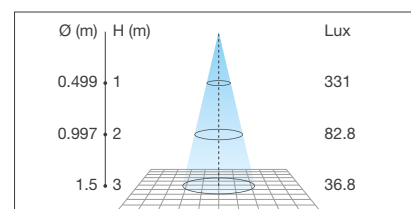



Codice accessori elettrici / *Electrical accessories code*

Power supply IP67

APP003.500

1 - 2

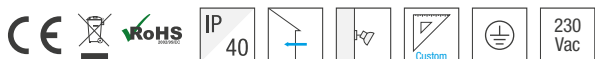

Testaletto con braccio flessibile, con interruttore.

Punto luce LED per lettura, versione con base rotonda (DE12R) oppure quadrata (DE12S) in diverse finiture. Emissione a 45° per ottenere un effetto di luce accentata.

Lunghezza braccio 350 mm, Ø 8 mm.

Fissaggio a parete tramite apposita staffa (in dotazione). Alimentazione a 230Vac.

Bedlight with flexible arm, with switch button.

LED point light source for reading, round base (DE12R) or square base (DE12S) in different finishes. Emission at 45° to have accent lighting. Length or arm 350 mm, Ø 8 mm.

Fixing at wall with special bracket (supplied).

Input voltage 230Vac.

Led color

1 = 3000°K (165 lumen)

Power supply

6 = 230Vac

Code

DE12R **DE12S**

Power

2W (1 LED HP SMD)

Led color

1

Spot

B

Power supply

6

Finishing

A-D-E

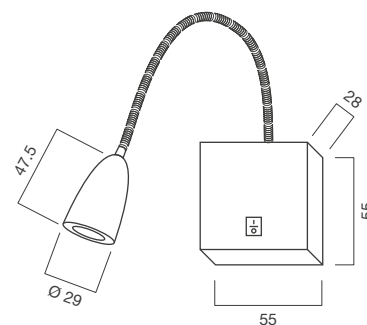
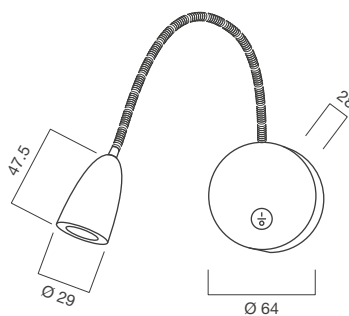

Spot



B = 45°

Finiture / Finishing



Bianco
White

A



Nichel spazzolato
Brushed nickel

D



Cromo
Chrome

E

Esempio codice / Code example

DE12R2W1B6E

Diagramma a cono rilevato con LED HP SMD, lente 45°, bianco caldo.

Cone diagram measured with warm white, HP SMD LED, lens 45°.

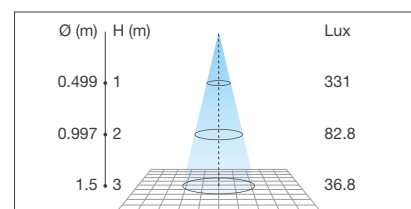



Codice accessori elettrici / *Electrical accessories code*

Power supply IP67

APP003.500

1 - 2



KARMA[®]
POWERLED LIGHTING



Draco

Apparecchi a LED da incasso per interni
LED recessed devices for indoor

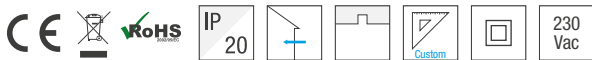

DR01-15

**Barra a LED da interno.**

Linea di prodotti completa ed elegante, in stile moderno minimal, possibilità di combinare diversi prodotti della medesima famiglia per ottenere uniformità dell'impianto illuminante, dando il giusto tono di luce ad ogni segmento dell'ambiente dove il prodotto viene collocato. La particolare conformazione del frontale in colore nero permette al prodotto di non emettere luce riflessa.

Indoor LED bar.

Refined and complete product line, in modern minimal style, granting the chance to combine different products of the same family to realize lighting systems uniformity, granting the right tone of light to every location portion where the item is being placed. The specific shape of the black item facade deny lighting glare spread.

Led color

- 1** = 3000°K (247 lumen)
2 = 6000°K (283 lumen)
9 = 4000°K (266 lumen)

Power supply

- 6** = 230Vac

Code	Power	Led color	Spot	Power supply	Finishing
DR01	2W (1 LED HP SMD)	1-2-9	A-B-N	6	A
DR02	2W (x 2 LED HP SMD)	1-2-9	A-B-N	6	A
DR05	2W (x 5 LED HP SMD)	1-2-9	A-B-N	6	A
DR10	2W (x 10 LED HP SMD)	1-2-9	A-B-N	6	A
DR15	2W (x 15 LED HP SMD)	1-2-9	A-B-N	6	A

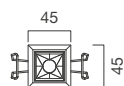
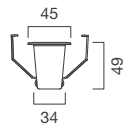

37x37 mm

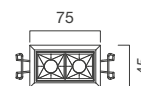
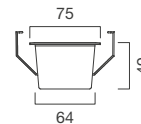

68x37 mm

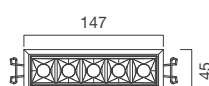
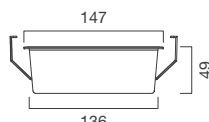

140x37 mm

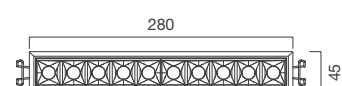
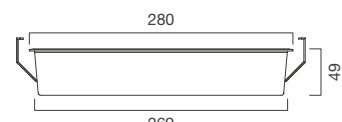

273x37 mm

Spot

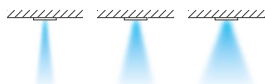

A = 15° N = 30° B = 45°

Finiture / Finishing



A

Esempio codice / Code example

DR052W9B6A

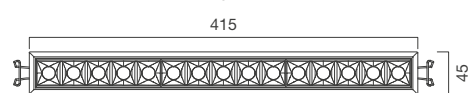
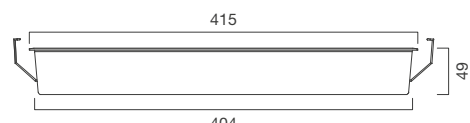

405x37 mm



Diagramma a coni rilevato con 1 LED HP SMD, lente 30°, bianco caldo.

Cone diagram measured with warm white, 1 HP SMD LED, lens 30°.



Diagramma a coni rilevato con 5 LED HP SMD, lente 45°, bianco caldo.

Cone diagram measured with warm white, 5 HP SMD LED, lens 45°.



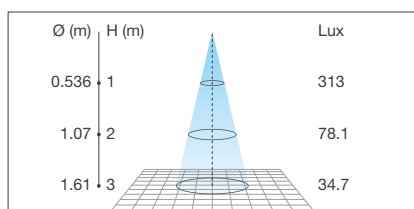
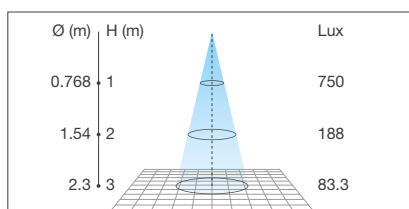

KARMA[®]
POWERLED LIGHTING



Pannelli

Apparecchi a LED da incasso per interni
LED recessed devices for indoor



PAN60

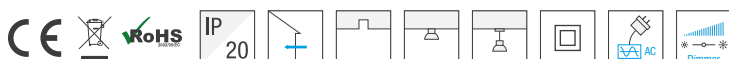

Pannelli luminosi a LED da interno, alimentatore incluso.

Telaio in alluminio verniciato bianco, diffusore opale.

Montaggio a muro, a incasso o a sospensione, per mezzo degli appositi accessori, fornibili a parte.

Ideale per aree ricettive, uffici e sale conferenze. Connessione tramite cavo.

LED panels for indoor, power supply unit included.

Frame in aluminum, white painted, opal diffuser.

Recessed mounting, wall or suspension mounting with suitable accessories, not included.

Ideal employment in leisure areas, offices and meeting rooms. Cable connection.

Power
36W (240 LED SMD)
44W (240 LED SMD)

Led color
BC = 2900-3200°K
BN = 4000-4500°K

Power supply
100/240Vac

Code	Power	Led color
PAN6036BC	36W	BC
PAN6036BN	36W	BN
PAN6044BC	44W	BC
PAN6044BN	44W	BN

Code PANM01
Molle per pannelli
PAN60/69/12
Spring for LED panels
PAN60/69/12



Code PANS01
Staffa di fissaggio a soffitto
ultra sottile per pannelli
PAN60/69/12
Ultra slim ceiling bracket
for LED panels PAN60/69/12

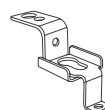

Code PANK04
Kit di sospensione con
cavetti in acciaio, 4 pz,
per pannelli PAN60/69/12
Suspension kit for LED panels
PAN60/69/12 with steel wires,
4 pieces of wires each kit

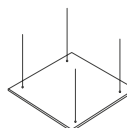

Code PANF6060
Telaio per pannelli PAN60/69
Frame for LED panels
PAN60/69

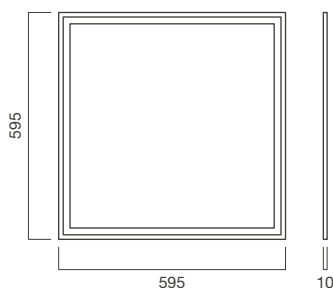

Spot



150°

Finitura / Finishing



Bianco
White

Diagramma a cono rilevato con LED SMD (36W), bianco naturale, emissione 150°.
Cone diagram measured with natural white, SMD LED (36W), 150° emission.



Diagramma a cono rilevato con LED SMD (44W), bianco naturale, emissione 150°.
Cone diagram measured with natural white, SMD LED (44W), 150° emission.



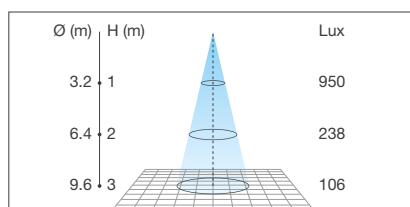
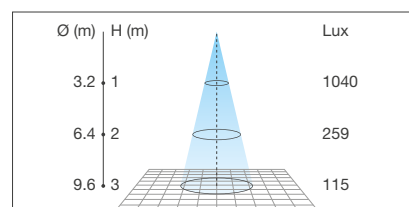

Codice accessori elettrici / *Electrical accessories code*

9600405020 Alimentatore esterno dimmerabile / *External dimmable driver*

EMG02 Kit Emergenza per LED universale / *Universal Emergency LED Kit*

PAN69UGR



Pannelli luminosi a LED da interno, alimentatore incluso, con valore UGR<19.

Telaio in alluminio verniciato bianco, diffusore opale.

Montaggio a muro, a incasso o a sospensione, per mezzo degli appositi accessori, fornibili a parte.

Ideale per ambienti pubblici o in luoghi dove la normativa prevede l'applicazione di questo tipo di prodotti.

LED panels for indoor, power supply unit included, with UGR<19.

Frame in aluminum, white painted, opal diffuser.

Recessed mounting, wall or suspension mounting with suitable accessories, not included.

Ideal for public environment and in any place where the legislation provides for the application of this type of product.

Power
44W (240 LED SMD)

Led color
BN = 4000-4500°K

Power supply
100/240Vac

Code	Power	Led color
PAN6944BN	44W	BN

Code PANM01
Molle per pannelli
PAN60/69/12
Spring for LED panels
PAN60/69/12



Code PANS01
Staffa di fissaggio a soffitto
ultra sottile per pannelli
PAN60/69/12
Ultra slim ceiling bracket
for LED panels PAN60/69/12



Code PANK04
Kit di sospensione con
cavetti in acciaio, 4 pz,
per pannelli PAN60/69/12
Suspension kit for LED panels
PAN60/69/12 with steel wires,
4 pieces of wires each kit

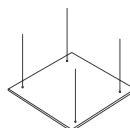

Code PANF6060
Telaio per pannelli PAN60/69
Frame for LED panels
PAN60/69

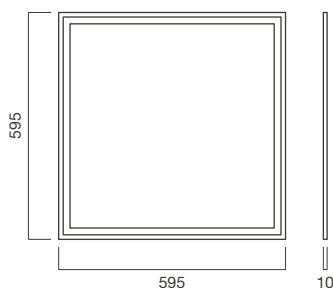
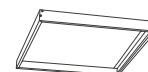

Spot



150°



Finitura / Finishing



Diagramma a cono rilevato con LED SMD, bianco naturale, emissione 150°.
Cone diagram measured with natural white, SMD LED, 150° emission.

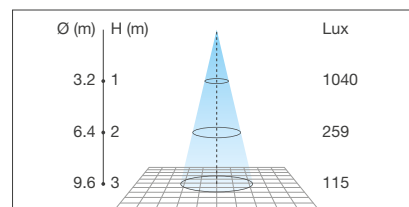



Codice accessori elettrici / *Electrical accessories code*

9600405020 Alimentatore esterno dimmerabile / *External dimmable driver*

EMG02 Kit Emergenza per LED universale / *Universal Emergency LED Kit*

PAN12

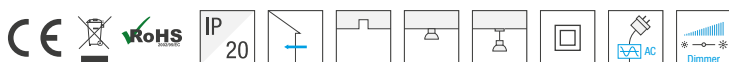

Pannelli luminosi a LED da interno, alimentatore incluso.

Telaio in alluminio verniciato bianco, diffusore opale.
 Montaggio a muro, a incasso o a sospensione, per mezzo degli appositi accessori, fornibili a parte.
 Ideale per aree ricettive e sale conferenze.
 Connessione tramite cavo.

LED panels for indoor, power supply unit included.

Frame in aluminum, white painted, opal diffuser.
 Recessed mounting, wall or suspension mounting with suitable accessories, not included.
 Ideal employment in leisure areas and meeting rooms. Cable connection.

Power
 44W (240 LED SMD)

Led color
 BN = 4000-4500°K

Power supply
 100/240Vac

Code	Power	Led color
PAN1244BN	44W	BN

Code PANM01
 Molle per pannelli
 PAN60/69/12
*Spring for LED panels
 PAN60/69/12*



Code PANS01
 Staffa di fissaggio a soffitto
 ultra sottile per pannelli
 PAN60/69/12
*Ultra slim ceiling bracket
 for LED panels PAN60/69/12*



Code PANK04
 Kit di sospensione con
 cavetti in acciaio, 4 pz,
 per pannelli PAN60/69/12
*Suspension kit for LED panels
 PAN60/69/12 with steel wires,
 4 pieces of wires each kit*

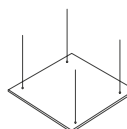

Code PANF1230
 Telaio per pannelli PAN12
Frame for LED panels PAN12

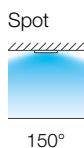

Finitura / Finishing

Bianco
 White



Diagramma a cono rilevato con LED SMD,
 bianco naturale, emissione 150°.
*Cone diagram measured with natural white,
 SMD LED, 150° emission.*



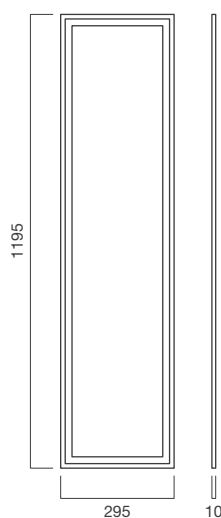
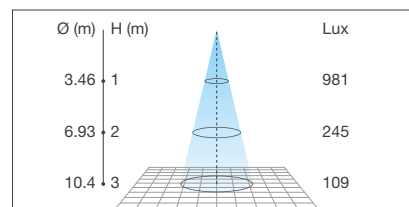

Codice accessori elettrici / *Electrical accessories code*

9600405020 Alimentatore esterno dimmerabile / *External dimmable driver*

EMG02 Kit Emergenza per LED universale / *Universal Emergency LED Kit*

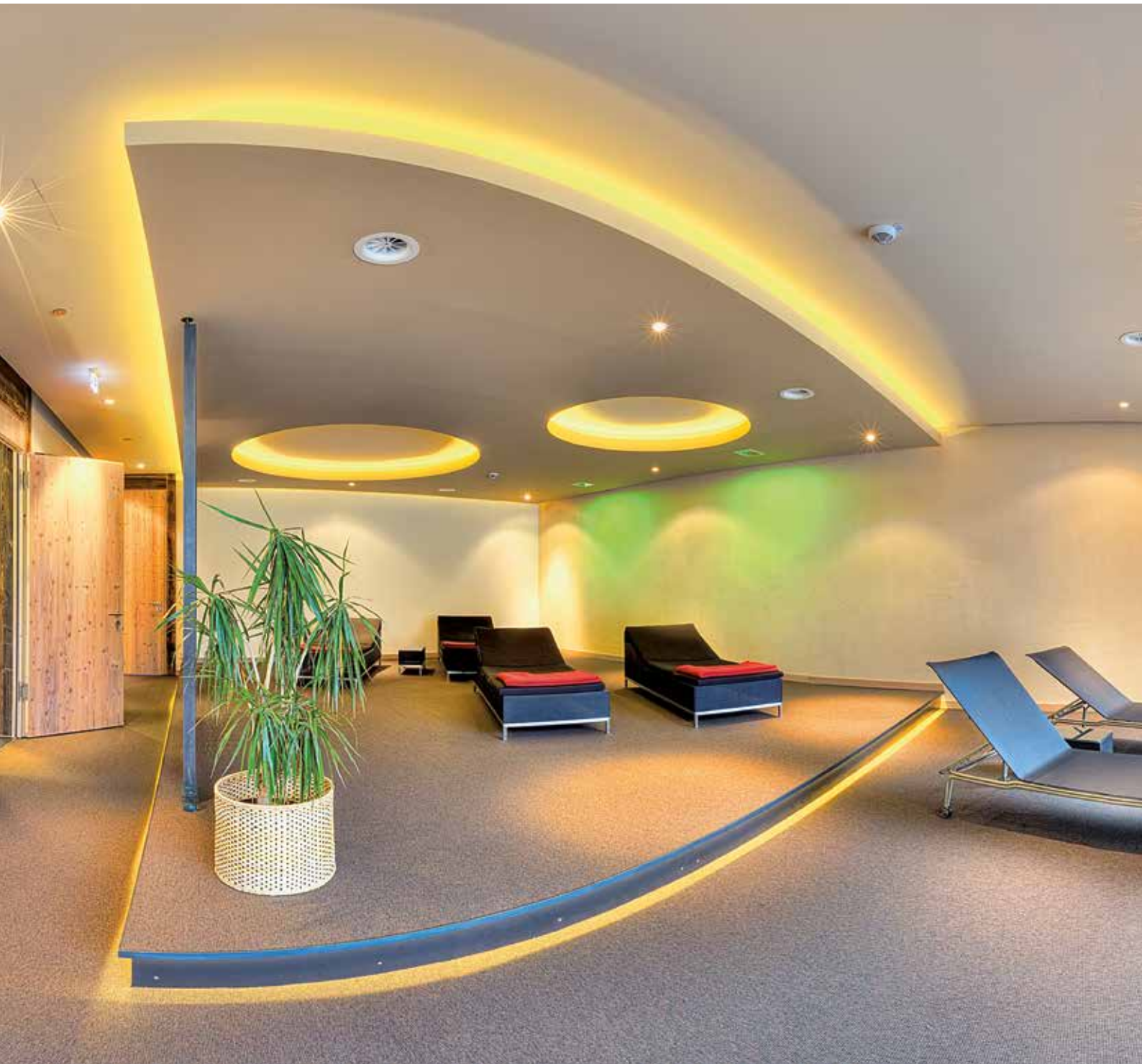

KARMA[®]
POWERLED LIGHTING



Strip

Strisce LED per interni ed esterni
Strip LED for indoor and outdoor



DO87N



Striscia a LED ad alta potenza e alta luminosità a 24Vdc per applicazioni decorative e illuminazioni, da montare con appositi profili dissipanti Karma e accessori testati per il prodotto.

Tipologia di LED selezionata per garantire uniformità, all'interno della striscia, per applicazioni Wall Washer.

Possibilità di ordinare varie tipologie di profili con appositi diffusori ottici, per ottenere effetti e ambientazioni particolari.

È disponibile una vasta gamma di accessori e alimentatori per soddisfare gran parte delle applicazioni, per ottenere effetti decorativi con comandi sia in DMX che Wi-Fi.

Opportunamente sezionabile per coprire tutte le esigenze di montaggio. Con appositi accessori la striscia diviene dimmerabile.

Adatta per illuminazione sia diretta che riflessa, nel caso di applicazioni estremamente gravose sono disponibili dei limitatori di corrente.

24Vdc High power LED strip, for decorative application and lighting.

To be used with Karma's heat sink profiles and approved accessories.

Selected LED for light uniformity, for using in Wall Washer applications.

Many profile types and optical diffuser are available, to obtain particular effects and settings.

Available a lot of accessories and power supply units, suitable for almost any application to obtain decorative effects with DMX or Wi-Fi control.

The strip LED is cuttable in custom length, to adapt it to any mounting requirement. The strip is dimmable with dedicated accessories.

Suitable for direct and reflected lighting.

Current limiters are available in case of heavy applications.



120°

Power/m 14,4W/m

Total power 72W

Led/m 60

Power supply

24 = 24Vdc

Color temperature

BC = 2900-3200°K (1150 lumen)

BN = 4000-4500°K (1200 lumen)

BF = 6000-7000°K (1250 lumen)

RGB

Esempio codice / Code example

DO87N2468BC



Per applicazioni interne.

Disponibile nella versione con Full Color RGB.

For indoor application.

Available in Full Color RGB version.

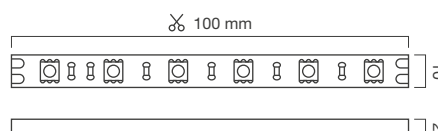

Code	DO87N		
Power supply	24		
IP	20		
Color temperature	BC-BN-BF-RGB		

Codice accessori elettrici / Electrical accessories code

Power supply IP20		Dimmer Controller IP20	
APT015.24	1 m	APT060.24	4 m
APT030.24	2 m	ALT100.24	5 m
APT060.24	3 m		
			CTR112DIM
			RGB Controller IP20
			AMP103

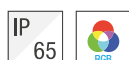

Per applicazioni interne ed esterne protette.
Elevata qualità della resina, resistente ai raggi UV.
Disponibile nella versione con Full Color RGB.
For indoor and protected outdoor application.
High quality UV resistant coating.
Available in Full Color RGB version.

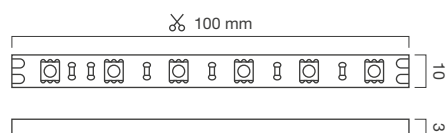

Code	DO87N
Power supply	24
IP	65
Color temperature	BC-BN-BF-RGB

Codice accessori elettrici / *Electrical accessories code*

Power supply IP20		Dimmer Controller IP20	
APT015.24	1 m	APT060.24	4 m
APT030.24	2 m	ALT100.24	5 m
APT060.24	3 m		
		RGB Controller IP20	
		AMP103	



Per applicazioni esterne o immersione fino a un metro. Da montare con collante speciale per silicone. Elevata qualità della guaina in silicone, resistente ai raggi UV. Per applicazioni immerse è possibile ordinare il prodotto con cavo su misura e sigillatura professionale.
For outdoor application. Resistant to immersion in water up to 1 meter.
To be fitted with special silicone adhesive. High quality UV resistant coating.
For underwater applications is possible to order the products with a custom length cable and a professional sealing.

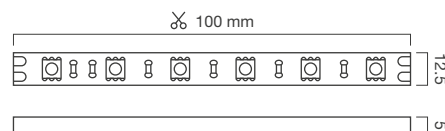

Code	DO87N
Power supply	24
IP	68
Color temperature	BC-BN-RGB

Codice accessori elettrici / *Electrical accessories code*

Power supply IP67		Dimmer Controller IP20	
ALP015.24	1 m	ALP060.24	4 m
ALP030.24	2 m	ALP120.24	5 m
ALP060.24	3 m		
		RGB Controller IP20	
		AMP103	

DO88N



Striscia a LED ad altissima potenza e altissima luminosità a 24Vdc per applicazioni decorative o illuminazione, da montare con appositi profili dissipanti Karma e accessori testati per il prodotto.

Tipologia di LED selezionata per garantire uniformità, all'interno della striscia, per applicazioni Wall Washer.

Possibilità di ordinare varie tipologie di profili con appositi diffusori ottici, per ottenere effetti e ambientazioni particolari.

È disponibile una vasta gamma di accessori e alimentatori per soddisfare gran parte delle applicazioni, per ottenere effetti decorativi con comandi sia in DMX che Wi-Fi.

Opportunamente sezionabile per coprire tutte le esigenze di montaggio. Con appositi accessori la striscia diviene dimmerabile.

Adatta per illuminazione sia diretta che riflessa, si raccomanda opportuna dissipazione per garantire la vita del prodotto viste le elevate prestazioni.

24Vdc very High power and very High brightness LED strip, for lighting or decorative application.

To be used with Karma's heat sink profiles and approved accessories.

Selected LED for light uniformity, for use in Wall Washer applications.

Many profile types and optical diffusers are available, to obtain particular effects and settings.

Available a wide range of accessories and power supply units, suitable for almost any application to obtain decorative effects with DMX or Wi-Fi control. The strip LED is cuttable in custom length, to adapt it to any mounting requirement. The strip is dimmable with dedicated accessories.

Suitable for lighting direct and reflected. Due to its high performance, a proper heat dissipation is recommended to guarantee product's life endurance.



120°

Power/m 24W/m

Total power 120W

Led/m 120

Power supply

24 = 24Vdc

Color temperature

BC = 2900-3200°K (2760 lumen)

BN = 4000-4500°K (2880 lumen)

BF = 6000-7000°K (3020 lumen)

IP
20

Per applicazioni interne.

For indoor application.

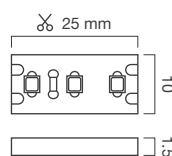

Code	DO88N
Power supply	24
IP	20
Color temperature	BC-BN-BF

IP
65

Per applicazioni interne ed esterne protette.

Elevata qualità della resina, resistente ai raggi UV.

For indoor and protected outdoor application.

High quality UV resistant coating used on IP65 version.

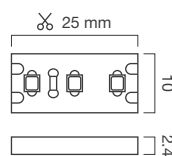

Code	DO88N
Power supply	24
IP	65
Color temperature	BC-BN-BF

Esempio codice / Code example

DO88N2420BC



Codice accessori elettrici / *Electrical accessories code*

Power supply IP20

APT030.24	1 m	APT100.24	4 m
APT060.24	2 m	APT150.24	5 m
APT100.24	3 m		

Dimmer Controller IP20 RGB Controller IP20

CTR112DIM	AMP103
-----------	--------

DO91N



Striscia a LED ultrasottile a media potenza e alta luminosità a 24Vdc per applicazioni decorative e illuminazioni. Adatta per effettuare decorazioni con l'utilizzo del profilo KARMA cod. PROF47N.

Tipologia di LED selezionata per garantire uniformità, all'interno della striscia, per applicazioni Wall Washer.

È disponibile una vasta gamma di accessori e alimentatori per soddisfare gran parte delle applicazioni, per ottenere effetti decorativi con comandi sia in DMX che Wi-Fi.

Opportunamente sezionabile per coprire tutte le esigenze di montaggio.

Con appositi accessori la striscia diviene dimmerabile.

Adatta per illuminazione sia diretta che riflessa, utilizzando apposito profilo dissipante.

Ultra slim 24Vdc Medium power and High brightness LED strip, for ornamental application or lighting.

Suitable to realize decoration with Karma profile code PROF47N.

Selected LED for light uniformity, for use in Wall Washer applications.

Available a wide range of accessories and power supply units, suitable for almost any application to obtain decorative effects with DMX or Wi-Fi control. The strip LED is cuttable in custom length, to adapt it to any mounting requirement. The strip is dimmable with dedicated accessories.

Suitable for lighting direct and reflected, using proper heatsink aluminum profile.

Power/m 9,6W/m

Power supply

24 = 24Vdc

Total power 48W

Color temperature

Led/m 120

BC = 2900-3200°K (910 lumen)

BN = 4000-4500°K (960 lumen)

BF = 6000-7000°K (1010 lumen)

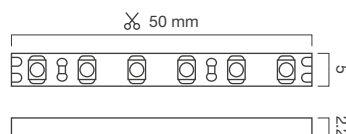

Code	DO91N
Power supply	24
IP	20
Color temperature	BC-BN-BF



120°

Esempio codice / Code example

DO91N2420BN



Codice accessori elettrici / *Electrical accessories code*

Power supply IP20

APT015.24	1 m	APT060.24	4 m
APT030.24	2 m	APT060.24	5 m
APT030.24	3 m		

Dimmer Controller IP20 RGB Controller IP20

CTR112DIM	AMP103
-----------	--------

DO92N



Striscia a LED a media potenza e media luminosità a 24Vdc per applicazioni decorative, da montare con appositi profili dissipanti Karma e accessori testati per il prodotto.

Tipologia di LED selezionata per garantire uniformità, all'interno della striscia, per applicazioni Wall Washer.

Possibilità di ordinare varie tipologie di profili con appositi diffusori ottici, per ottenere effetti particolari e ambientazioni particolari.

È disponibile una vasta gamma di accessori e alimentatori per soddisfare gran parte delle applicazioni, per ottenere effetti decorativi con comandi sia in DMX che Wi-Fi.

Opportunamente sezionabile per coprire tutte le esigenze di montaggio. Con appositi accessori la striscia diviene dimmerabile.

24Vdc Medium power and Medium brightness LED strip, for decorative application.

To be used with Karma's heat sink profiles and approved accessories.

Selected LED for light uniformity, for use in Wall Washer applications.

Many profile types and optical diffusers are available, to obtain particular effects and settings.

Available a wide range of accessories and power supply units, suitable for almost any application to obtain decorative effects with DMX or Wi-Fi control. The strip LED is cuttable in custom length, to adapt it to any mounting requirement. The strip is dimmable with dedicated accessories.

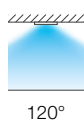

Power/m 4,8W/m

Total power 24W

Led/m 60

Power supply

24 = 24Vdc

Color temperature

BC = 2900-3200°K (440 lumen)

BN = 4000-4500°K (480 lumen)

BL = Blu / Blue

Esempio codice / Code example

DO92N2465BL

IP 20

Per applicazioni interne.

For indoor application.

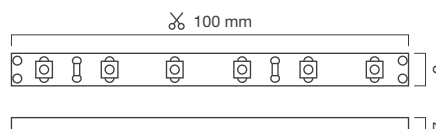

Code **DO92N**

Power supply **24**

IP **20**

Color temperature **BC-BN**



IP 65

Per applicazioni interne ed esterne protette.

Elevata qualità della resina, resistente ai raggi UV.

For indoor and protected outdoor application.

High quality UV resistant coating used on IP65 version.

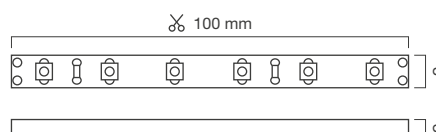

Code **DO92N**

Power supply **24**

IP **65**

Color temperature **BC-BN-BL**



Codice accessori elettrici / *Electrical accessories code*

Power supply IP20

APT006.24	1 m	APT030.24	4 m
APT015.24	2 m	APT030.24	5 m
APT015.24	3 m		

Dimmer Controller IP20 RGB Controller IP20

CTR112DIM	AMP103
AL288D/P	

DO94N



Striscia a LED a media potenza e alta luminosità a 24Vdc per applicazioni decorative o illuminazione, da montare con appositi profili dissipanti Karma e accessori testati per il prodotto.

Tipologia di LED selezionata per garantire uniformità, all'interno della striscia, per applicazioni Wall Washer.

Possibilità di ordinare varie tipologie di profili con appositi diffusori ottici, per ottenere effetti e ambientazioni particolari.

È disponibile una vasta gamma di accessori e alimentatori per soddisfare gran parte delle applicazioni, per ottenere effetti decorativi con comandi sia in DMX che Wi-Fi.

Opportunamente sezionabile per coprire tutte le esigenze di montaggio. Con appositi accessori la striscia diviene dimmerabile.

Adatta per illuminazione sia diretta che riflessa, utilizzando apposito profilo dissipante.

24Vdc Medium power and High brightness LED strip, for decorative application or lighting.

To be used with Karma's heat sink profiles and approved accessories.

Selected LED for light uniformity, for use in Wall Washer applications.

Many profile types and optical diffusers are available, to obtain particular effects and settings.

Available a wide range of accessories and power supply units, suitable for almost any application to obtain decorative effects with DMX or Wi-Fi control. The strip LED is cuttable in custom length, to adapt it to any mounting requirement. The strip is dimmable with dedicated accessories. Suitable for lighting direct and reflected using proper heatsink aluminum profiles.

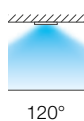

Power/m 9,6W/m

Total power 48W

120°

Led/m 120

Power supply

24 = 24Vdc

Color temperature

BC = 2900-3200°K (910 lumen)

BN = 4000-4500°K (960 lumen)

BF = 6000-7000°K (1010 lumen)

Esempio codice / Code example

DO94N2420BN

IP 20

Per applicazioni interne.

For indoor application.

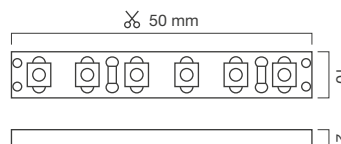

Code **DO94N**

Power supply **24**

IP **20**

Color temperature **BC-BN**



IP 65

Per applicazioni interne ed esterne protette.

Elevata qualità della resina, resistente ai raggi UV.

For indoor and protected outdoor application.

High quality UV resistant coating used on IP65 version.

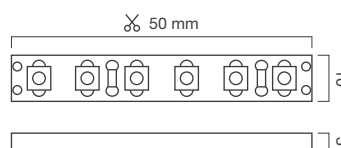

Code **DO94N**

Power supply **24**

IP **65**

Color temperature **BC-BN-BF**



Codice accessori elettrici / *Electrical accessories code*

Power supply IP20

APT015.24	1 m	APT060.24	4 m
APT030.24	2 m	APT060.24	5 m
APT030.24	3 m		

Dimmer Controller IP20 RGB Controller IP20

CTR112DIM	AMP103
AL288D/P	

DO95N



Striscia a LED ad altissima potenza e altissima luminosità a 24Vdc per applicazioni decorative o illuminazione, da montare con appositi profili dissipanti Karma e accessori testati per il prodotto.

Tipologia di LED selezionata per garantire uniformità, all'interno della striscia, per applicazioni Wall Washer ed effetti striscia continua di luce. Possibilità di ordinare varie tipologie di profili con appositi diffusori ottici, per ottenere effetti particolari e ambientazioni particolari.

È disponibile una vasta gamma di accessori e alimentatori per soddisfare gran parte delle applicazioni, per ottenere effetti decorativi con comandi sia in DMX che Wi-Fi.

Opportunamente sezionabile per coprire tutte le esigenze di montaggio. Con appositi accessori la striscia diviene dimmerabile.

Adatta per illuminazione sia diretta che riflessa, si raccomanda opportuna dissipazione per garantire la vita del prodotto viste le elevate prestazioni.

24Vdc very High power and very High brightness LED strip, for lighting or decorative application.

To be used with Karma's heat sink profiles and approved accessories.

Selected LED for light uniformity, for use in Wall Washer application and continuous line of light effect.

Many profile types and optical diffusers are available, to obtain particular effects and settings.

Available a wide range of accessories and power supply units, suitable for almost any application to obtain decorative effects with DMX or Wi-Fi control. The strip LED is cuttable in custom length, to adapt it to any mounting requirement. The strip is dimmable with dedicated accessories.

Suitable for lighting direct and reflected. Due to its high performance, a proper heat dissipation is recommended to guarantee product's life endurance.

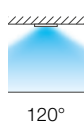

Power/m 19,2W/m

Total power 96W

Led/m 240

Power supply

24 = 24Vdc

Color temperature

BC = 2900-3200°K (1520 lumen)

BN = 4000-4500°K (1680 lumen)

Esempio codice / Code example

DO95N2465BN



Per applicazioni interne.

For indoor application.

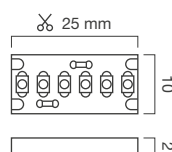

Code **DO95N**

Power supply **24**

IP **20**

Color temperature **BC-BN**



Per applicazioni interne ed esterne protette.

Elevata qualità della resina, resistente ai raggi UV.

For indoor and protected outdoor application.

High quality UV resistant coating used on IP65 version.

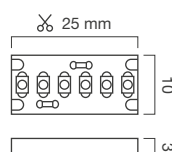

Code **DO95N**

Power supply **24**

IP **65**

Color temperature **BC-BN**



Codice accessori elettrici / *Electrical accessories code*

Power supply IP20

APT030.24	1 m	ALT100.24	4 m
APT060.24	2 m	ALT100.24	5 m
APT060.24	3 m		

Dimmer Controller IP20 RGB Controller IP20

CTR112DIM	AMP103
AL288D/P	

DO97N



Striscia a LED a media potenza e media luminosità a 24Vdc in RGB e BIANCO per applicazioni decorative e illuminazione interne ed esterne protette, da montare con appositi profili dissipanti Karma e accessori testati per il prodotto. Elevata qualità della resina, resistente ai raggi UV. Tipologia di LED selezionata per garantire uniformità, all'interno della striscia, per applicazioni Wall Washer ad effetto Full Color e bianco. Possibilità di ordinare varie tipologie di profili con appositi diffusori ottici, per ottenere effetti particolari e ambientazioni sia mono che a miscelazione di colori.

È disponibile una vasta gamma di accessori e alimentatori per soddisfare gran parte delle applicazioni per ottenere effetti decorativi con comandi in DMX o Radiofrequenza.

Opportunamente sezionabile per coprire tutte le esigenze di montaggio.

Con appositi accessori la striscia diviene dimmerabile.

Con questo prodotto si possono ottenere gli effetti RGB Full Color in abbinamento alla qualità della luce bianca.

Per avere le massime prestazioni luminose e di effetto vanno usate le apposite centraline RGBW Karma.

24Vdc Medium power and Medium brightness LED strip, RGB and WHITE, for indoor and protected external ornamental application or lighting.

To be used with Karma's heat sink profiles and approved accessories.

High quality UV resistant coating.

Selected LED for light uniformity, for use in Wall Washer applications with Full Color and white effect.

Many profile types and optical diffusers are available, to obtain particular effects and settings, single or color mixing.

Available a wide range of accessories and power supply units, suitable for almost any application to obtain decorative effects with DMX or Radiofrequency control.

The strip LED is cuttable in custom length, to adapt it to any mounting requirement. The strip is dimmable with dedicated accessories.

With this product you can get RGB Full Color effects combined with the quality of white light.

For maximum performance and brightness, use the special RGBW Karma control units.

Power/m 8,6+8,6W/m

Power supply

24 = 24Vdc

Total power 43+43W

Color temperature

BC = 2900-3200°K+RGB (1150 lumen)

BN = 4000-4500°K+RGB (1200 lumen)

Led/m 72

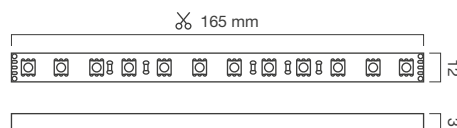

Code	DO97N
Power supply	24
IP	65
Color temperature	BC-BN



120°

Esempio codice / Code example

DO97N2465BC



Codice accessori elettrici / *Electrical accessories code*

Power supply IP20

APT030.24	1 m	ALT100.24	4 m
APT060.24	2 m	ALT100.24	5 m
APT060.24	3 m		

RGBW Controller IP20

RGB8
RGB13N

Resinatura profili IP68

Processo attraverso il quale avviene il rivestimento della barra/strip LED con un film sottile di resina in grado di proteggere il prodotto dalle aggressioni esterne.

Tramite tale trattamento protettivo, la barra d'illuminazione a LED manterrà inalterata la propria funzionalità e qualità nel tempo, correttamente isolata dall'ambiente esterno e al sicuro da polvere, smog e umidità.

La resina utilizzata permette l'impermeabilizzazione del prodotto fino a un grado di protezione IP68 (IP6x protetto completamente contro la penetrazione della polvere - IPx8 protetto contro gli effetti dell'immersione prolungata a profondità superiore a 1 m).

Resin coated profiles IP68

Process through which LED bars or strips are coated with a thin layer of resin able to protect product from external aggressions.

Through such protective treatment, LED illuminating bar will keep its functionality and quality unaltered in time and will be correctly insulated from external environment and safe from dust, smog and humidity.

Used resin allow the waterproofing of the profile up to IP68 protection (i.e. IP6x means completely protected from dust penetration - IPx8 means protected against effects of prolonged immersion to depth higher than 1 m).





Barra LED su misura

Karma da sempre si offre per la realizzazione di prodotti Custom, riuscendo ad offrire alla clientela il prodotto più adatto abbinabile alle esigenze progettuali o estetiche del cliente. Una volta decise le caratteristiche tecniche del prodotto, il nostro reparto assistenza tecnica si offre per dare supporto al cliente nella scelta del profilo più appropriato con relativi accessori come tappi o staffe, abbinato alla cover e alla fonte luminosa. Il tutto non dimenticando il contesto di applicazione del prodotto.

Si può personalizzare la lunghezza della barra così come la lunghezza dei cavi di connessione e tipo di luce.

Inviateci senza impegno il vostro disegno, i nostri tecnici realizzeranno il vostro profilo nelle dimensioni progettate.

Custom-made profile

Karma offers always itself for the delivery of Custom products, managing to offer to customers the most suitable product that can be combined with the customer's design or aesthetic needs.

Once the technical characteristics of the product have been decided, our technical support department is offered to give support to customer in choosing of the most appropriate profile with relevant accessories (caps or brackets), combined with the cover and light source. All without forgetting the product application context.

You can customize the length of the bar as well as the length of the connection cables and the type of light.

Send us your design without obligation, our technicians will realize your profile in the designed dimensions.

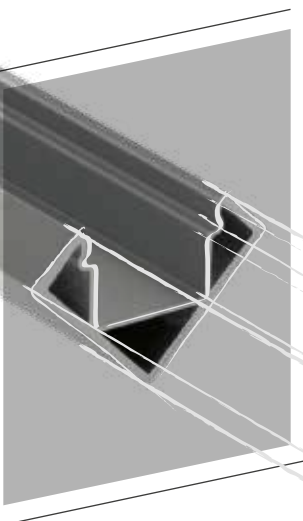

Per maggiori informazioni,
contattaci al numero:
*For more information, please
contact us at phone number:*

+39 041 5830442

KARMA[®]
POWERLED LIGHTING

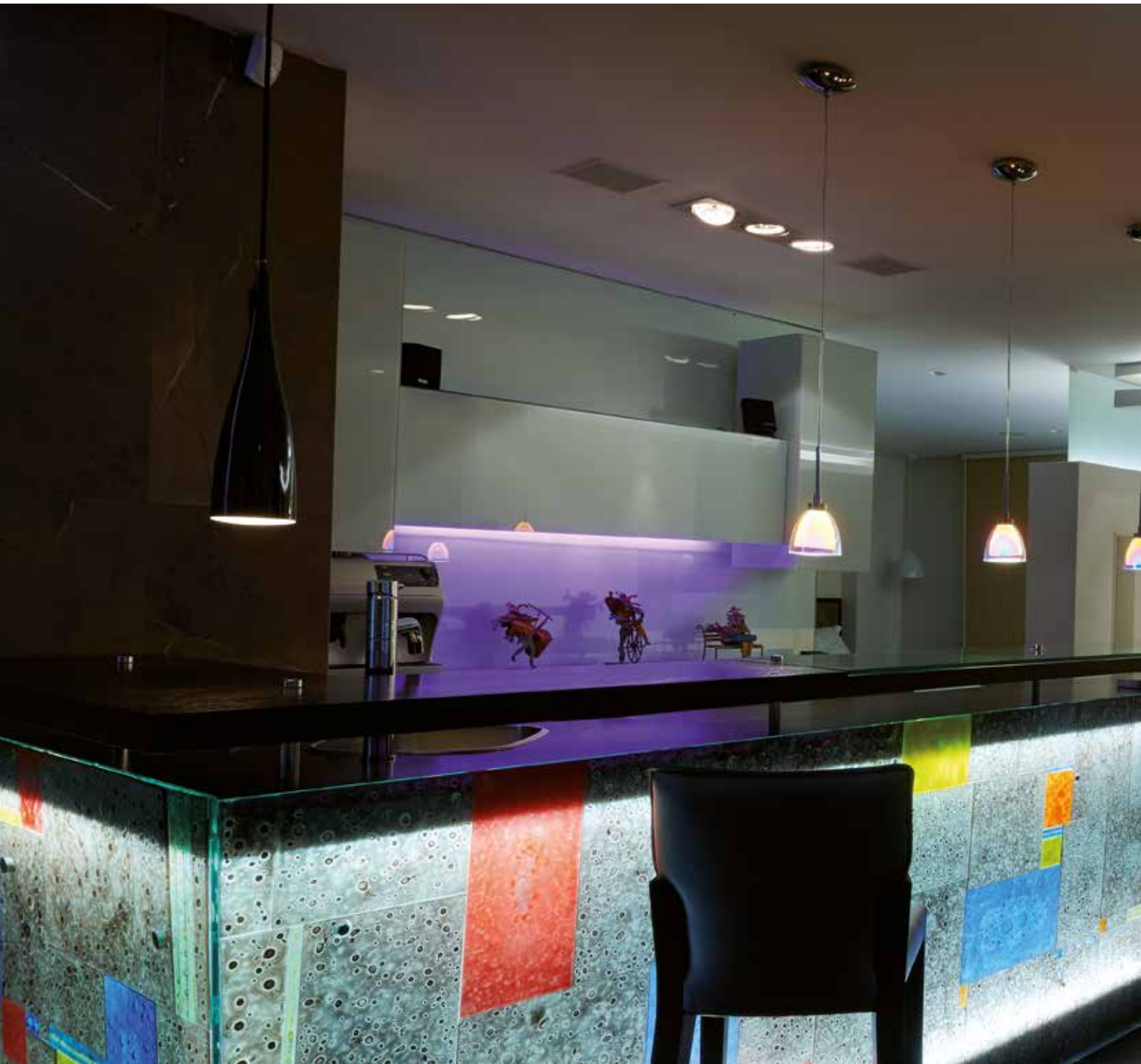

KARMA[®]
POWERLED LIGHTING



Profili

Profili per strisce LED
Strip LED profiles

PROF1



Profilo in alluminio estruso anodizzato grigio argento per installazioni ad incasso filo muro e a vista, dove sia previsto l'uso di strip LED IP20, IP65 e IP68. Utilizzabile per uso decorativo per interni ed esterni protetti. Disponibili una gamma di diffusori e tappi.

Extruded aluminum profile, silver gray anodized. For wall-level recessed or visible installations, where is expected the use of LED strip IP20, IP65 and IP68. Suitable for indoor and protected outdoor decorative applications. Wide range of closing caps and diffusers.

L. 2000 mm

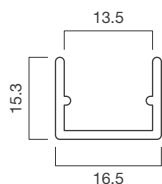

Code PLEX1
Diffusore in PMMA satinato
Satin diffuser in PMMA
L. 2000 mm

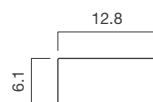

Code PLEX5
Diffusore in policarbonato trasparente, lente 30°
Transparent diffuser in polycarbonate, lens 30°
L. 2000 mm

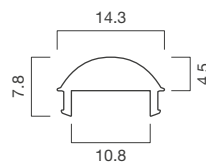

Code PLEX22
Diffusore in policarbonato opale
Opal diffuser in polycarbonate
L. 2000 mm

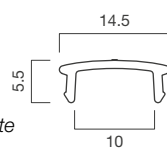

Code PLEX21
Diffusore in policarbonato trasparente
Transparent diffuser in polycarbonate
L. 2000 mm

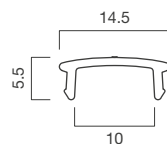

Code TPTK11
Kit 2 tappi chiusura per PROF1
Set of 2 pieces of end caps, for PROF1

Finitura profilo / Profile finishing



Esempio codici ordine / Example order codes

Codice profilo / Profile code Codice diffusore / Diffuser code Codice accessori / Accessories code

PROF1 + **PLEX5** + **TPTK11**





Piattina in alluminio estrusa anodizzata grigio argento.
Ideale per la dissipazione delle strip LED.
Previsto l'uso con strisce LED IP20 e IP65.
Consigliata per uso interno.
Disponibile su richiesta il KIT montaggio cod. DIST2, il cui uso è necessario tutte le volte che l'installazione delle strisce viene effettuata su materiali termicamente isolanti ed infiammabili.

*Extruded aluminum flat, silver gray anodized.
Ideal for dissipation of strip LEDs.
Compatible with LED strip IP20 and IP65.
Recommended for indoor use.
Available on request the mounting kit code DIST2, whose use is necessary every time that LED strips are installed on thermally insulated or inflammable materials.*

L. 2000 mm



Code DIST2
Kit 10 pezzi distanziatore
per profilo
*Kit 10 pieces spacer
for profile*

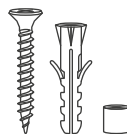

Finitura profilo / Profile finishing



Grigio argento
Silver gray

Esempio codici ordine / Example order codes

Codice profilo / Profile code

Codice accessori / Accessories code

PROF2

+

DIST2

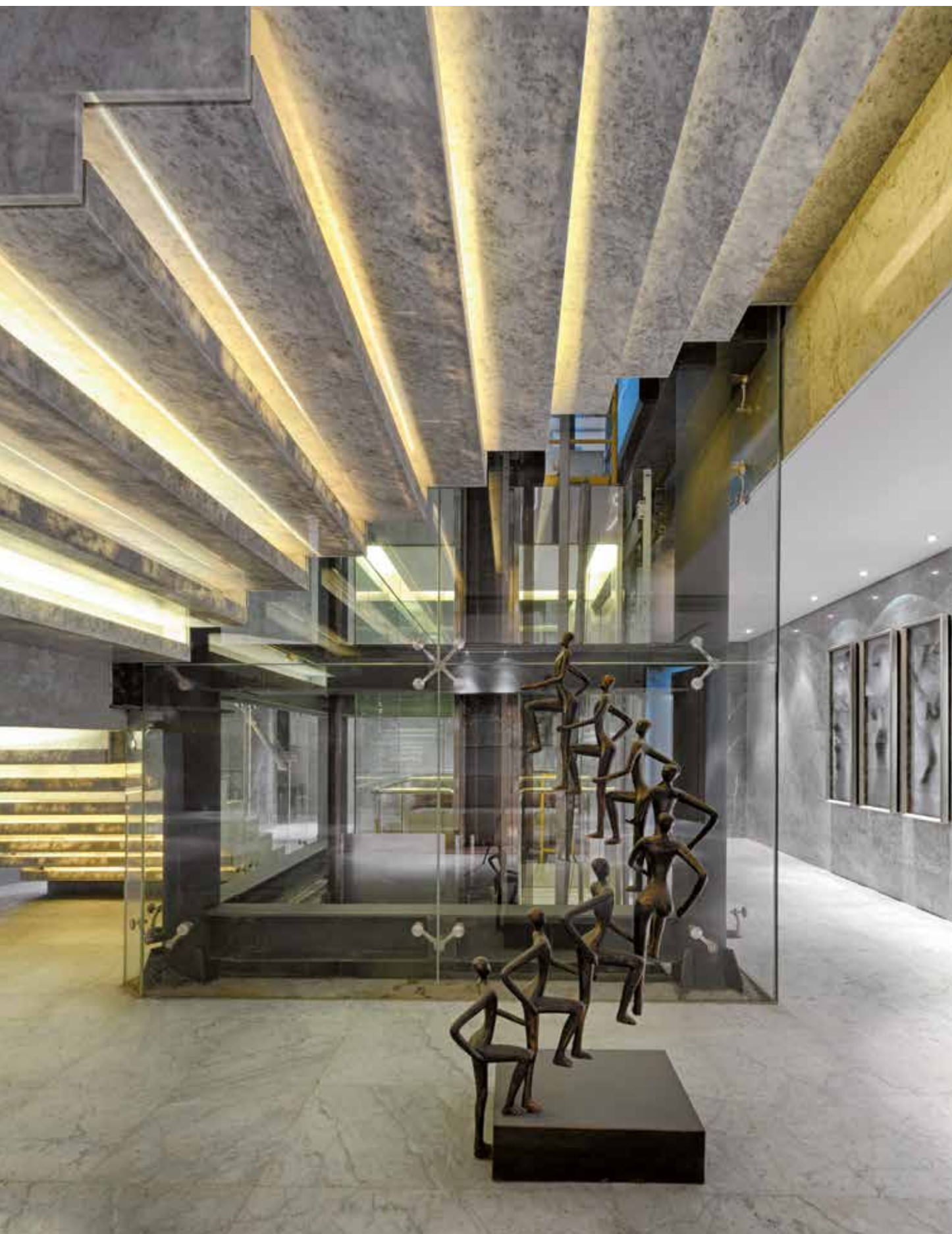

PROF3



Profilo in alluminio estruso a basso profilo di colore grigio alluminio per installazioni a vista. Previsto l'uso con strip LED IP20, IP65 e IP68. Previsto l'uso decorativo da interni ed esterni protetti. Idoneo per montaggio su pareti a 90°. Vasta gamma di diffusori e tappi.

Extruded aluminum profile, low thickness, silver gray anodized for visible installations. Compatible with LED strip IP20, IP65 and IP68. Adapt to indoor and protected outdoor decorative applications.

Suitable for 90° wall mounting. Wide range of closing caps and diffusers.

L. 2000 mm

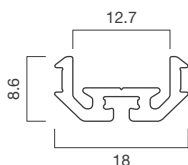

Code PLEX5
Diffusore in policarbonato trasparente, lente 30°
Transparent diffuser in polycarbonate, lens 30°
L. 2000 mm

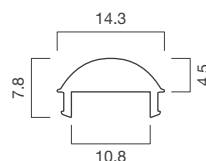

Code TPTK35
Kit 2 tappi chiusura per PROF3+PLEX5
Set of 2 pieces of end caps, for PROF3+PLEX5

Code PLEX22
Diffusore in policarbonato opale
Opal diffuser in polycarbonate
L. 2000 mm

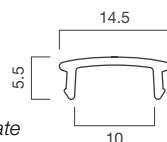

Code TPTK32
Kit 2 tappi chiusura per PROF3+PLEX22/21
Set of 2 pieces of end caps, for PROF3+PLEX22/21

Code PLEX21
Diffusore in policarbonato trasparente
Transparent diffuser in polycarbonate
L. 2000 mm

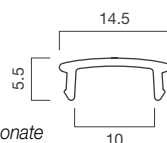

Code TPTK33
Kit 2 tappi chiusura per PROF3+PLEX32
Set of 2 pieces of end caps, for PROF3+PLEX32

Code PLEX32
Diffusore in PMMA satinato bombato
Satin convex diffuser in PMMA
L. 2000 mm

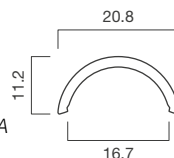

Code PLEX51N
Diffusore in PMMA trasparente, lente 30° / *Transparent diffuser in PMMA, lens 30°*
L. 2000 mm

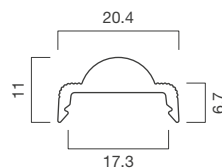

Code CL4
Kit 4 clip montaggio per tutta la serie PROF3
Set of 4 pieces of mounting clip, for complete serie of PROF3

Finitura profilo / *Profile finishing*



Esempio codici ordine / *Example order codes*

Codice profilo / *Profile code* Codice diffusore / *Diffuser code* Codice accessori / *Accessories code*
PROF3 + **PLEX22** + **TPTK32 + CL4**



PROF4



Profilo in alluminio estruso anodizzato grigio argento per installazioni a vista, con possibilità di passaggio cavi fino a 6x1.5 mm². Previsto l'uso con strip LED IP20, IP65 e IP68. Clips per montaggio a muro facilitato anche per pareti poco regolari.

Idoneo per montaggio su pareti a 90°.

Vasta gamma di tappi di chiusura e diffusori.

Staffe per trasformazione di profilo in barra luminosa orientabile. Kit per trasformazione del profilo in sospensione.

Extruded aluminum profile, silver gray anodized for visible installations, cables through up to 6x1.5 mm². Compatible with LED strip IP20, IP65 and IP68. Clips to facilitate wall mounting also for irregular walls. Suitable for 90° wall mounting. Wide range of closing caps and diffusers. Bracket to transform the profile in a orientable light bar. Kit to transform the profile in a pendant lamp.

L. 2000 mm

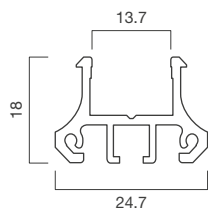

Finitura profilo / Profile finishing



Code PLEX5
Diffusore in policarbonato trasparente, lente 30°
Transparent diffuser in polycarbonate, lens 30°
L. 2000 mm

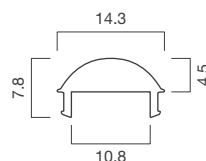

Code PLEX22
Diffusore in policarbonato opale
Opal diffuser in polycarbonate
L. 2000 mm

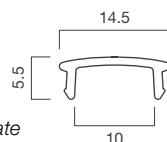

Code PLEX21
Diffusore in policarbonato trasparente
Transparent diffuser in polycarbonate
L. 2000 mm

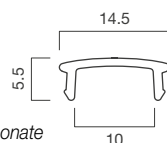

Code PLEX32
Diffusore in PMMA satinato bombato
Satin convex diffuser in PMMA
L. 2000 mm

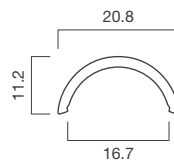

Code TPTK45
Kit 2 tappi chiusura per PROF4+PLEX5
Set of 2 pieces of end caps, for PROF4+PLEX5

Code TPTK42
Kit 2 tappi chiusura per PROF4+PLEX22/21
Set of 2 pieces of end caps, for PROF4+PLEX22/21

Code TPTK43
Kit 2 tappi chiusura per PROF4+PLEX32
Set of 2 pieces of end caps, for PROF4+PLEX32

Code TPKK4
Kit 2 cavetti sospensione per PROF4
Suspension kit, composed by 2 pieces of wires in steel, for PROF4

Code TPMK4
Kit 3 clip fissaggio a parete per PROF4
Kit of springs for flat wall mounting, for PROF4. Set composed by 3 springs PROF4

Code TPSK4
Kit 2 staffe per PROF4
Kit of 2 pieces of brackets, for PROF4

Esempio codici ordine / Example order codes

Codice profilo / Profile code Codice diffusore / Diffuser code Codice accessori / Accessories code
PROF4 + **PLEX32** + **TPTK43 + TPKK4**



PROF43N



Profilo in alluminio estruso a bordi arrotondati anodizzato grigio argento. Doppia larghezza e basso profilo per alloggiare fino a due strip LED IP20 e IP65 fino a 2x9.6W/m. Costruita con estetica particolare per poter essere installata in mobili e cucine con effetto mini plafoniera. Disponibili tappi e clips di montaggio su superfici.

Extruded aluminum profile with rounded edges, silver gray anodized. Double width and low thickness to accept up to two LED strips IP20 and IP65 up to 2x9.6W/m.

Built with a specific design to be installed in furniture and kitchen as mini ceiling light. Available caps and surface mounting clips.

L. 2000 mm

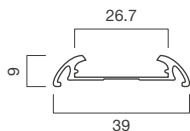

Code PLEX43N

Diffusore in policarbonato opale

Opal diffuser in polycarbonate

L. 2000 mm

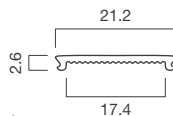

Code TP43N

Kit 2 tappi chiusura per PROF43N

Set of 2 pieces of end caps, for PROF43N

Code CL43N

Kit 4 clip montaggio per PROF43N

Set of 4 pieces of mounting clip, for PROF43N

Finitura profilo / Profile finishing



Grigio argento
Silver gray

Esempio codici ordine / Example order codes

Codice profilo / Profile code

PROF43N

Codice diffusore / Diffuser code

+ PLEX43N

Codice accessori / Accessories code

+ TP43N + CL43N



PROF47N



Micro profilo in alluminio anodizzato, creato per poter alloggiare strip LED con larghezza 5 mm (es: strip LED cod. DO91N).
Diffusore opale per emissione omogenea della luce, disponibili tappi di chiusura e clip di montaggio.

*Micro profile in anodized aluminum, designed to accommodate LED strips with 5 mm width (for example: LED strip code DO91N).
Opal diffusers for homogeneous light emission, end caps and mounting clips are available.*

L. 2000 mm

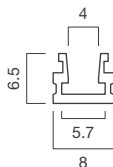

Code PLEX47N
Diffusore in polycarbonato opale
Opal diffuser in polycarbonate
L. 2000 mm

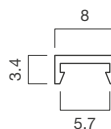

Code TP47N
Kit 2 tappi chiusura per PROF47N
Set of 2 pieces of end caps, for PROF47N

Code CL47N
Kit 4 clip montaggio per PROF47N
Set of 4 pieces of mounting clip, for PROF47N

Finitura profilo / Profile finishing



Grigio argento
Silver gray

Esempio codici ordine / Example order codes

Codice profilo / Profile code Codice diffusore / Diffuser code Codice accessori / Accessories code
PROF47N + **PLEX47N** + **TP47N + CL47N**



PROF54N



Profilo in alluminio anodizzato per installazioni ad incasso a soffitto, adatto per ottenere l'effetto di guida luminosa continua a scomparsa.

La profondità del profilo e il diffusore satinato, garantiscono l'omogeneità dell'emissione della luce, senza far notare i punti luminosi dei LED. Le dimensioni del prodotto permettono l'installazione fino a 2 strip LED da 14,4W/m max cad. Adatto per l'installazione nel cartongesso grazie alle apposite molle. Su richiesta sono disponibili i tappi di chiusura.

Anodized aluminum profile for recessed ceiling installation, suitable to obtain the effect of a hidden continue light guide. The depth of the profile and the satin diffuser ensure the homogeneity of the emission of light, without seeing the LED light points. The size of the product permits the installation till up 2 x14,4W/m strip LEDs. Suitable for plasterboard installation, with special springs. On request, end caps are available.

L. 2000 mm

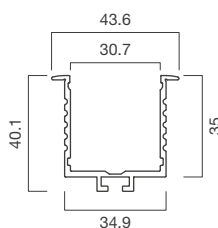

Finitura profilo / Profile finishing



Code PLEX54N
Diffusore in PMMA satinato
Satin diffuser in PMMA
L. 2000 mm

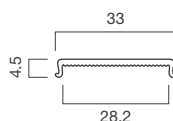

Code TP54N
Kit 2 tappi chiusura per PROF54N
Set of 2 pieces of end caps, for PROF54N

Code CL54N
Kit 4 clip montaggio per PROF54N
Set of 4 pieces of mounting clip, for PROF54N

Esempio codici ordine / Example order codes

Codice profilo / Profile code Codice diffusore / Diffuser code Codice accessori / Accessories code
PROF54N + **PLEX54N** + **TP54N + CL54N**



PROF61N



Micro profilo angolare in alluminio anodizzato grigio argento. Adatto in tutte quelle applicazioni angolari ottenendo una emissione di luce con angolo a 100°. Per le sue ridotte dimensioni può essere alloggiato sia in armadi che cucine montando strip LED di 4.8W/m massimo. Disponibili tappi e clips di supporto.

Aluminum angular micro profile, silver gray anodized. Adapt in all angular applications, obtaining a 100° angle light emission. For its reduced sizes it can be housed in wardrobes or in kitchen, mounting LEDs strip up to 4.8W/m. Caps and mounting clips availables.

L. 2000 mm

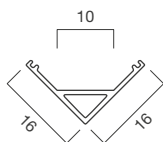

Code PLEX61N
Diffusore in policarbonato
opale bombato
*Opal convex diffuser
in polycarbonate*
L. 2000 mm

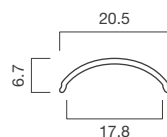

Code TP61N
Kit 2 tappi chiusura per PROF61N
Set of 2 pieces of end caps, for PROF61N

Code CL61N
Kit 4 clip montaggio per PROF61N
Set of 4 pieces of mounting clip, for PROF61N

Finitura profilo / Profile finishing



Grigio argento
Silver gray

Esempio codici ordine / Example order codes

Codice profilo / Profile code Codice diffusore / Diffuser code Codice accessori / Accessories code
PROF61N + **PLEX61N** + **TP61N + CL61N**



PROF62N



Profilo angolare in alluminio anodizzato grigio argento. Adatto in tutte quelle applicazioni angolari ottenendo una emissione di luce con angolo a 100°. Per le sue ridotte dimensioni può essere alloggiato sia in armadi che cucine montando strip LED di 9.6W/m massimo. Avendo dei bordi di raffreddamento può essere applicato in situazioni di lavoro gravose. Possibilità di passaggio cavi all'interno del profilo. Disponibili tappi e clips di supporto.

Aluminum angular profile, silver gray anodized. Adapt in all angular applications, obtaining a 100° angle light emission. For its sizes it can be housed in wardrobes or in kitchen, mounting LEDs strip up to 9.6W/m. It can be used in heavy working conditions, due to its heat sinking edges. Possible to inside wire trough. Caps and mounting clips availables.

L. 2000 mm

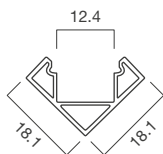

Finitura profilo / Profile finishing



Grigio argento
Silver gray

Code PLEX62N

Diffusore in polycarbonato
opale

Opal diffuser in polycarbonate

L. 2000 mm

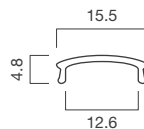

Code TP62N

Kit 2 tappi chiusura per PROF62N

Set of 2 pieces of end caps, for PROF62N

Code CL62N

Kit 4 clip montaggio per PROF62N

Set of 4 pieces of mounting clip, for PROF62N

Esempio codici ordine / Example order codes

Codice profilo / Profile code

PROF62N

Codice diffusore / Diffuser code

+ PLEX62N

Codice accessori / Accessories code

+ TP62N + CL62N



PROF63N



Profilo angolare in alluminio anodizzato grigio argento. Adatto in tutte quelle applicazioni angolari ottenendo una emissione di luce con angolo a 100°. Per le sue dimensioni può alloggiare strip LED di 2x9.6W/m. Disponibili tappi e clips di supporto. Con striscia a 240 LED/m si può ottenere un effetto di luce continua e con appositi cavetti di sospensione può diventare anche una mini plafoniera.

Aluminum angular profile, silver gray anodized. Adapt in all angular applications, obtaining a 100° angle light emission. For its sizes it can mounting LEDs strip up to 2x9.6W/m. Available caps and mounting clips. With 240 LED/m strip, it can obtain a continuous light effect. With dedicated suspending wires it can become a mini ceiling light.

L. 2000 mm

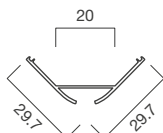

Finitura profilo / Profile finishing



Grigio argento
Silver gray

Code PLEX63N

Diffusore in policarbonato
opale bombato
Opal convex diffuser
in polycarbonate

L. 2000 mm

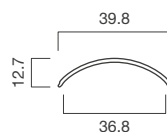

Code TP63N

Kit 2 tappi chiusura per PROF63N

Set of 2 pieces of end caps, for PROF63N

Code CL63N

Kit 4 clip montaggio per PROF63N

Set of 4 pieces of mounting clip, for PROF63N

Code CAV63N

Kit sospensione per PROF63N

Suspension kit, for PROF63N

Esempio codici ordine / Example order codes

Codice profilo / Profile code

Codice diffusore / Diffuser code

Codice accessori / Accessories code

PROF63N

+

PLEX63N

+

TP63N + CAV63N



PROF72N



Profilo in alluminio anodizzato per installazioni a parete, effetto veletta monoemissione per una diffusione della luce radente alla parete. Ideale per illuminare il soffitto nascondendo la fonte luminosa. Disponibili clip di fissaggio e tappi di chiusura.

Anodized aluminum profile for wall mounting, single way light effect for diffusion of grazing light on the wall.

Ideal for illuminating the ceiling by hiding the light source.

Available fixing clips and end caps.

L. 2000 mm

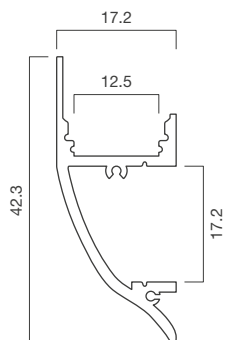

Code PROF72N

Profilo in alluminio anodizzato
Anodized aluminum profile

L. 2000 mm

Code PROF72BI

Profilo in alluminio anodizzato bianco
White anodized aluminum profile

L. 2000 mm

Code PLEX72N

Diffusore in policarbonato opale
Opal diffuser in polycarbonate

L. 2000 mm

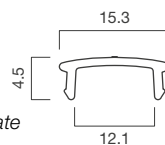

Code PLEX73N

Diffusore in policarbonato trasparente
Transparent diffuser in polycarbonate

L. 2000 mm

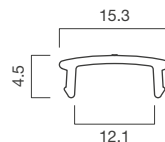

Code TP72N

Kit 2 tappi chiusura grigi per PROF72N
Set of 2 pieces of gray end caps, for PROF72N

Code TP72NBI

Kit 2 tappi chiusura bianchi per PROF72N
Set of 2 pieces of white end caps, for PROF72N

Code CL7273N

Kit 4 clip montaggio per PROF72N/73N
Set of 4 pieces of mounting clip, for PROF72N/73N

Finitura profilo / Profile finishing



Grigio argento
Silver gray



Bianco
White

Esempio codici ordine / Example order codes

Codice profilo / Profile code

PROF72N

Codice diffusore / Diffuser code

+ PLEX73N

Codice accessori / Accessories code

+ TP72N + CL7273N



PROF73N



Profilo in alluminio anodizzato per installazioni a parete, effetto veletta biemissione per una diffusione della luce radente alla parete. Ideale per creare effetti decorativi. Disponibili clip di fissaggio e tappi di chiusura.

Anodized aluminum profile for wall mounting, double way light effect for diffusion of grazing light on the wall.

Ideal for creating decorative effect on the wall. Available fixing clips and end caps.

L. 2000 mm

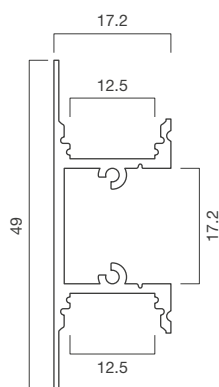

Code PROF73N
Profilo in alluminio anodizzato
Anodized aluminum profile
L. 2000 mm

Code PROF73BI
Profilo in alluminio anodizzato bianco
White anodized aluminum profile
L. 2000 mm

Code TP73N
Kit 2 tappi chiusura per PROF73N
Set of 2 pieces of end caps, for PROF73N

Code CL7273N
Kit 4 clip montaggio per PROF72N/73N
Set of 4 pieces of mounting clip, for PROF72N/73N

Code PLEX72N
Diffusore in policarbonato opale
Opal diffuser in polycarbonate
L. 2000 mm

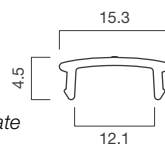

Code PLEX73N
Diffusore in policarbonato trasparente
Transparent diffuser in polycarbonate
L. 2000 mm

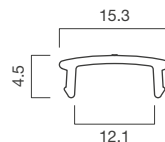

Finitura profilo / Profile finishing



Esempio codici ordine / Example order codes

Codice profilo / Profile code Codice diffusore / Diffuser code Codice accessori / Accessories code
PROF73BI + **PLEX72N** + **TP73N + CL7273N**



PROF48N



Profilo in alluminio estruso anodizzato flessibile, ideale per l'installazione su superfici curve a vista oppure irregolari.
Spessore compatto per poter essere modellato seguendo curve omogenee.

Flexible anodized extruded aluminum profile, ideal for installation on irregular wall or curved surfaces at sight.

Compact thickness to be able to be molded fitting homogeneous curves.

L. 2000 mm

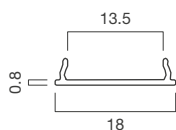

Code PLEX48N
Diffusore in PMMA opale
Opal diffuser in PMMA
L. 2000 mm

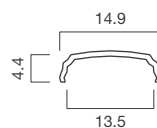

Code PLEX49N
Diffusore in PMMA trasparente
Transparent diffuser in PMMA
L. 2000 mm

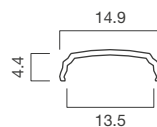

Code TP48N
Kit 2 tappi chiusura per PROF48N
Set of 2 pieces of end caps, for PROF48N

Code TPSK48N
Kit 2 staffe per PROF48N
Kit of 2 pieces of brackets, for PROF48N



Finitura profilo / Profile finishing



Esempio codici ordine / Example order codes

Codice profilo / Profile code Codice diffusore / Diffuser code Codice accessori / Accessories code

PROF48N + **PLEX49N** + **TP48N + TPSK48N**



PROF80N



Profilo universale in alluminio estruso, anodizzato argento. Disegnato per abbinarsi ai profili cod. PROF81N, PROF82N, PROF83N, PROF86N, PROF87N, PROF88N, PROF89N. Ideale per passaggio cavi. Con i relativi accessori, permette a questi profili di essere installati a parete, a soffitto, a incasso, a sospensione oppure orientabili.

Universal silver anodized aluminum profile. Designed to match the items PROF81N, PROF82N, PROF83N, PROF86N, PROF87N, PROF88N, PROF89N. Ideal for cable passage. With its accessories, it is possible to install these profiles at wall, ceiling, recessed, suspended or adjustable mounting.

L. 2000 mm

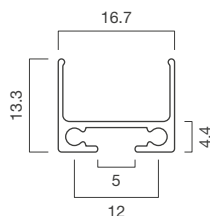

Code CL80N

Kit 4 clip montaggio per PROF80N
Mounting kit for PROF80N composed by 4 clips.

Code CAV80N

Kit 2 cavi acciaio sospensione per PROF80N
Suspension kit for PROF80N composed by 2 steel wires

Code CL80S

Kit supporti orientabili per PROF80N
Kit of adjustable support for PROF80N

Finitura profilo / Profile finishing



Grigio argento
Silver gray

Esempio codici ordine / Example order codes

Codice profilo / Profile code

Codice accessori / Accessories code

PROF80N

+

CL80S



PROF81N



Profilo in alluminio a basso spessore, di dimensioni contenute.
Disponibili tappi di chiusura e clip di montaggio. Abbinando il profilo universale PROF80N e gli accessori relativi, si ha la possibilità di ottenere un profilo con passaggio cavi, per il quale sono disponibili il kit per montaggio a parete o soffitto, kit per sospensione o trasformare il profilo in barra luminosa orientabile.

Low thickness aluminum profile, small dimensions item.

End caps and mounting clips are available.

By combining the universal profile item code PROF80N and its accessories, you have the option of obtaining a cable passage profile for which you can have kits for mounting at wall or ceiling, suspension kit or transform the profile in adjustable light bar.

L. 2000 mm

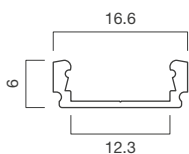

Finitura profilo / Profile finishing



Grigio argento
Silver gray

Code PLEX81N

Diffusore in policarbonato opale
Opal diffuser in polycarbonate
L. 2000 mm

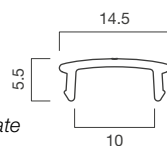

Code PLEX82N

Diffusore in policarbonato trasparente
Transparent diffuser in polycarbonate
L. 2000 mm

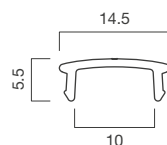

Code TP81N

Kit 2 tappi chiusura per PROF81N
Set of 2 pieces of end caps, for PROF81N

Code CL81N

Kit 4 clip montaggio per PROF81N/82N
Set of 4 pieces of mounting clip, for PROF81N/82N

Code TP8081N

Kit 2 tappi chiusura per PROF80N/81N
Set of 2 pieces of end caps, for PROF80N/81N

Esempio codici ordine / Example order codes

Codice profilo / Profile code

Codice diffusore / Diffuser code

Codice accessori / Accessories code

PROF81N

+

PLEX82N

+

TP81N + CL81N

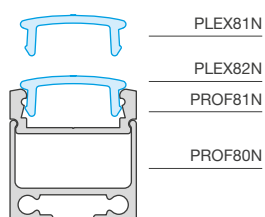

Code PROF80N
 Profilo in alluminio
 anodizzato universale
*Universal anodized
 aluminum profile*
 L. 2000 mm

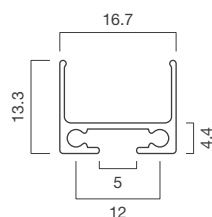

Code CL80N
 Kit 4 clip montaggio per PROF80N
*Mounting kit for PROF80N composed
 by 4 clips*

Code CAV80N
 Kit 2 cavi acciaio sospensione
 per PROF80N
*Suspension kit for PROF80N composed
 by 2 steel wires*

Code CL80S
 Kit supporti orientabili per PROF80N
Kit of adjustable support for PROF80N profile



Esempio codici ordine con accessori opzionali / *Example order codes with optional accessories*

Codice profilo / <i>Profile code</i>	Codice diffusore / <i>Diffuser code</i>	Codice accessori / <i>Accessories code</i>
PROF81N + PROF80N	+ PLEX82N	+ TP8081N + CL80S

PROF82N



Profilo in alluminio, di dimensioni contenute. Disponibili tappi di chiusura e clip di montaggio. Abbinando il profilo universale PROF80N e gli accessori relativi, si ha la possibilità di ottenere un profilo con passaggio cavi, per il quale sono disponibili il kit per montaggio a parete o soffitto, kit per sospensione o trasformare il profilo in barra luminosa orientabile.

Small dimension aluminum profile. End caps and mounting clips are available. By combining the universal profile item code PROF80N and its accessories, you have the option of obtaining a cable passage profile for which you can have kits for mounting at wall or ceiling, suspension kit or transform the profile in adjustable light bar.

L. 2000 mm

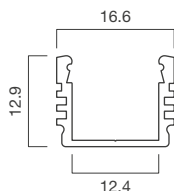

Finitura profilo / Profile finishing



Grigio argento
Silver gray

Code PLEX81N

Diffusore in polycarbonato opale
Opal diffuser in polycarbonate
L. 2000 mm

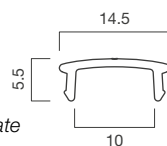

Code PLEX82N

Diffusore in polycarbonato trasparente
Transparent diffuser in polycarbonate
L. 2000 mm

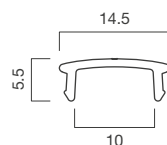

Code TP82N

Kit 2 tappi chiusura per PROF82N
Set of 2 pieces of end caps, for PROF82N

Code CL81N

Kit 4 clip montaggio per PROF81N/82N
Set of 4 pieces of mounting clip, for PROF81N/82N

Code TP8082N

Kit 2 tappi chiusura per PROF80N/82N
Set of 2 pieces of end caps, for PROF80N/82N

Esempio codici ordine / Example order codes

Codice profilo / Profile code Codice diffusore / Diffuser code Codice accessori / Accessories code
PROF82N + **PLEX81N** + **TP82N + CL81N**

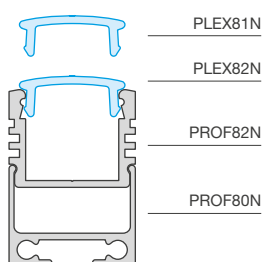

Code PROF80N
 Profilo in alluminio
 anodizzato universale
*Universal anodized
 aluminum profile*
 L. 2000 mm

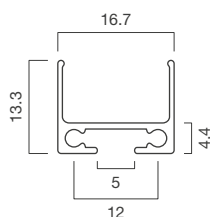

Code CL80N
 Kit 4 clip montaggio per PROF80N
*Mounting kit for PROF80N composed
 by 4 clips*

Code CAV80N
 Kit 2 cavi acciaio sospensione
 per PROF80N
*Suspension kit for PROF80N composed
 by 2 steel wires*

Code CL80S
 Kit supporti orientabili per PROF80N
Kit of adjustable support for PROF80N profile



Esempio codici ordine con accessori opzionali / *Example order codes with optional accessories*

Codice profilo / *Profile code* Codice diffusore / *Diffuser code* Codice accessori / *Accessories code*

PROF82N + PROF80N + **PLEX81N** + **TP8082N + CAV80N**

PROF83N



Profilo in alluminio, di dimensioni contenute, idoneo per montaggio ad incasso.
Disponibili tappi di chiusura e clip di montaggio. Abbinando il profilo universale PROF80N e gli accessori relativi, si ha la possibilità di ottenere un profilo con passaggio cavi, per il quale sono disponibili il kit per montaggio a parete o soffitto, kit per sospensione o trasformare il profilo in barra luminosa orientabile.

Small dimension aluminum profile, suitable for recessed mounting.

End caps and mounting clips are available.

By combining the universal profile item code PROF80N and its accessories, you have the option of obtaining a cable passage profile for which you can have kits for mounting at wall or ceiling, suspension kit or transform the profile in adjustable light bar.

L. 2000 mm

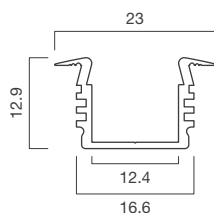

Finitura profilo / Profile finishing



Code PLEX81N
Diffusore in policarbonato opale
Opal diffuser in polycarbonate
L. 2000 mm

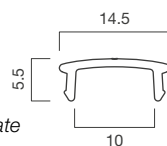

Code PLEX82N
Diffusore in policarbonato trasparente
Transparent diffuser in polycarbonate
L. 2000 mm

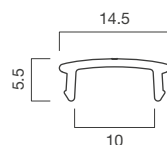

Code TP83N
Kit 2 tappi chiusura per PROF83N
Set of 2 pieces of end caps, for PROF83N

Code TP8083N
Kit 2 tappi chiusura per PROF80N/83N
Set of 2 pieces of end caps, for PROF80N/83N

Esempio codici ordine / Example order codes

Codice profilo / Profile code Codice diffusore / Diffuser code Codice accessori / Accessories code
PROF83N + **PLEX81N** + **TP83N**

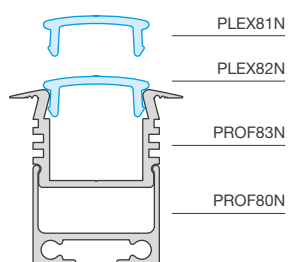

Code PROF80N
 Profilo in alluminio
 anodizzato universale
*Universal anodized
 aluminum profile*
 L. 2000 mm

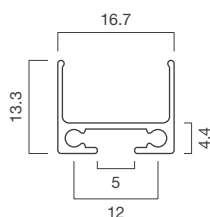

Code CL80N
 Kit 4 clip montaggio per PROF80N
*Mounting kit for PROF80N composed
 by 4 clips*

Code CAV80N
 Kit 2 cavi acciaio sospensione
 per PROF80N
*Suspension kit for PROF80N composed
 by 2 steel wires*

Code CL80S
 Kit supporti orientabili per PROF80N
Kit of adjustable support for PROF80N profile



Esempio codici ordine con accessori opzionali / *Example order codes with optional accessories*

Codice profilo / <i>Profile code</i>	Codice diffusore / <i>Diffuser code</i>	Codice accessori / <i>Accessories code</i>
PROF83N + PROF80N	+ PLEX81N	+ TP8083N + CL80S

PROF86N



Profilo in alluminio a basso spessore, di dimensioni molto contenute. Abbinato al diffusore rettangolare oppure bombato si ottiene l'uniformità dell'emissione luminosa. Disponibili tappi di chiusura in abbinamento alle diverse forme di diffusori.

Abbinando il profilo universale PROF80N e gli accessori relativi, si ha la possibilità di ottenere un profilo con passaggio cavi, per il quale sono disponibili il kit per montaggio a parete o soffitto, kit per sospensione o trasformare il profilo in barra luminosa orientabile.

Low thickness aluminum profile, small dimensions item. Combined with the rectangular or convex diffuser, the uniformity of the light emission is obtained. End caps are available in combination with the different cover profiles. By combining the universal profile item code PROF80N and its accessories, you have the option of obtaining a cable passage profile for which you can have kits for mounting at wall or ceiling, suspension kit or transform the profile in adjustable light bar. Available caps and surface mounting clips.

L. 2000 mm

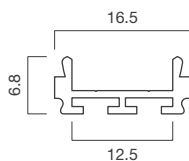

Finitura profilo / Profile finishing



Code PLEX83N
Diffusore in policarbonato opale
Opal diffuser in polycarbonate
L. 2000 mm

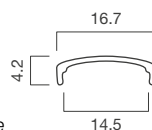

Code PLEX84N
Diffusore in policarbonato opale rettangolare
Opal rectangular diffuser in polycarbonate
L. 2000 mm

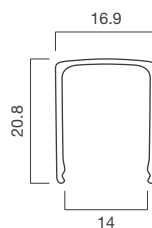

Code PLEX85N
Diffusore in policarbonato opale bombato
Opal convex diffuser in polycarbonate
L. 2000 mm

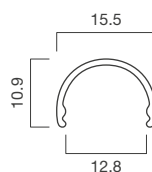

Code TP8683N
Kit 2 tappi chiusura per PROF86N+PLEX83N
Set of 2 pieces of end caps, for PROF86N +PLEX83N

Code TP8684N
Kit 2 tappi chiusura per PROF86N+PLEX84N
Set of 2 pieces of end caps, for PROF86N +PLEX84N

Code TP8685N
Kit 2 tappi chiusura per PROF86N+PLEX85N
Set of 2 pieces of end caps, for PROF86N +PLEX85N

Code TP808683N
Kit 2 tappi chiusura per PROF80N/86N+PLEX83N
Set of 2 pieces of end caps, for PROF80N/86N +PLEX83N

Code TP808684N
Kit 2 tappi chiusura per PROF80N/86N+PLEX84N
Set of 2 pieces of end caps, for PROF80N/86N +PLEX84N

Code TP808685N
Kit 2 tappi chiusura per PROF80N/86N+PLEX85N
Set of 2 pieces of end caps, for PROF80N/86N +PLEX85N

Esempio codici ordine / Example order codes

Codice profilo / Profile code Codice diffusore / Diffuser code Codice accessori / Accessories code
PROF86N + **PLEX84N** + **TP8684N**

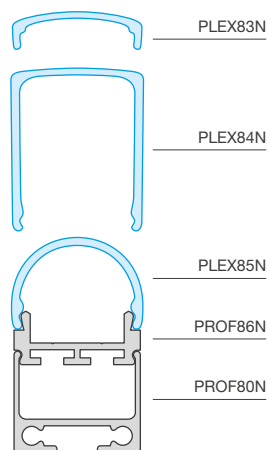

Code PROF80N
 Profilo in alluminio
 anodizzato universale
*Universal anodized
 aluminum profile*
 L. 2000 mm

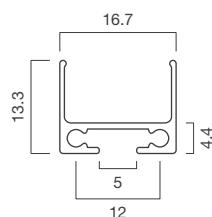

Code CL80N
 Kit 4 clip montaggio per PROF80N
*Mounting kit for PROF80N composed
 by 4 clips*

Code CAV80N
 Kit 2 cavi acciaio sospensione
 per PROF80N
*Suspension kit for PROF80N composed
 by 2 steel wires*

Code CL80S
 Kit supporti orientabili per PROF80N
Kit of adjustable support for PROF80N profile



Esempio codici ordine con accessori opzionali / *Example order codes with optional accessories*

Codice profilo / *Profile code* Codice diffusore / *Diffuser code* Codice accessori / *Accessories code*

PROF86N + PROF80N + **PLEX84N** + **TP808684N + CL80S**

PROF87N



Profilo in alluminio a basso spessore, di dimensioni molto contenute, idoneo per montaggio ad incasso. Disponibili tappi di chiusura e clip di montaggio. Abbinando il profilo universale PROF80N e gli accessori relativi, si ha la possibilità di ottenere un profilo con passaggio cavi, per il quale sono disponibili il kit per montaggio a parete o soffitto, kit per sospensione o trasformare il profilo in barra luminosa orientabile.

Low thickness aluminum profile, small dimensions item, suitable for recessed mounting.

End caps and mounting clips are available. By combining the universal profile item code PROF80N and its accessories, you have the option of obtaining a cable passage profile for which you can have kits for mounting at wall or ceiling, suspension kit or transform the profile in adjustable light bar.

L. 2000 mm

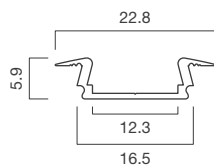

Finitura profilo / Profile finishing



Code PLEX81N
Diffusore in polycarbonato opale
Opal diffuser in polycarbonate
L. 2000 mm

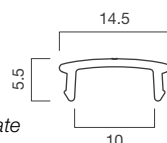

Code PLEX82N
Diffusore in polycarbonato trasparente
Transparent diffuser in polycarbonate
L. 2000 mm

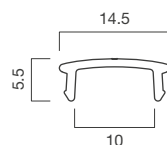

Code TP87N
Kit 2 tappi chiusura per PROF87N
Set of 2 pieces of end caps, for PROF87N

Code TP8087N
Kit 2 tappi chiusura per PROF80N/87N
Set of 2 pieces of end caps, for PROF80N/87N

Esempio codici ordine / Example order codes

Codice profilo / Profile code Codice diffusore / Diffuser code Codice accessori / Accessories code
PROF87N + **PLEX81N** + **TP87N**

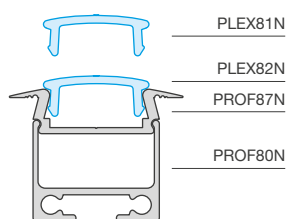

Code PROF80N
 Profilo in alluminio
 anodizzato universale
*Universal anodized
 aluminum profile*
 L. 2000 mm

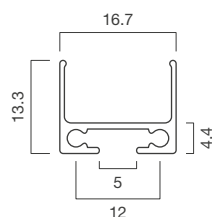

Code CL80N
 Kit 4 clip montaggio per PROF80N
*Mounting kit for PROF80N composed
 by 4 clips*

Code CAV80N
 Kit 2 cavi acciaio sospensione
 per PROF80N
*Suspension kit for PROF80N composed
 by 2 steel wires*

Code CL80S
 Kit supporti orientabili per PROF80N
Kit of adjustable support for PROF80N profile



Esempio codici ordine con accessori opzionali / *Example order codes with optional accessories*

Codice profilo / Profile code	Codice diffusore / Diffuser code	Codice accessori / Accessories code
PROF87N + PROF80N	+ PLEX81N	+ TP8087N + CAV80N

PROF88N



Profilo in alluminio anodizzato per installazioni a parete o a soffitto. La profondità del profilo permette l'omogeneità dell'emissione della luce, senza far notare i punti luminosi dei LED. L'effetto è ancora maggiore con l'impiego del diffusore rettangolare oppure bombato. Le dimensioni del prodotto permettono l'installazione fino a 2 Strip LED da 14,4W/m max cad. Disponibili tappi di chiusura in abbinamento alle diverse forme di diffusori. Abbinando il profilo universale PROF80N e gli accessori relativi, si ha la possibilità di ottenere un profilo con passaggio cavi, per il quale sono disponibili il kit per montaggio a parete o soffitto, kit per sospensione o trasformare il profilo in barra luminosa orientabile.

Anodized aluminum profile for wall or ceiling installation. The depth of the profile allows the homogeneity emission of the light, without noticing the LED light points. The effect is even greater with the use of the rectangular or convex cover profiles. The product dimensions allow up to 2x14,4W/m max Strip LEDs. End caps are available in combination with the different cover profiles. By combining the universal profile item code PROF80N and its accessories, you have the option of obtaining a cable passage profile for which you can have kits for mounting at wall or ceiling, suspension kit or transform the profile in adjustable light bar.

Finitura profilo / Profile finishing



Grigio argento
Silver gray

Code PLEX86N

Diffusore in polycarbonato opale

Opal diffuser in polycarbonate

L. 2000 mm

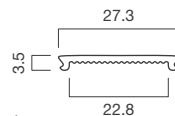

Code TP8886N

Kit 2 tappi chiusura per PROF88N/89N + PLEX86N

Set of 2 pieces of end caps, for PROF88N/89N + PLEX86N

Code PLEX87N

Diffusore in polycarbonato opale quadrato

Opal square diffuser in polycarbonate

L. 2000 mm

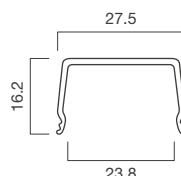

Code TP8887N

Kit 2 tappi chiusura per PROF88N/89N + PLEX87N

Set of 2 pieces of end caps, for PROF88N/89N + PLEX87N

Code PLEX89N

Diffusore in polycarbonato opale bombato

Opal convex diffuser in polycarbonate

L. 2000 mm

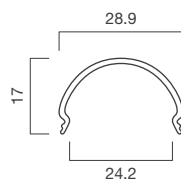

Code TP8889N

Kit 2 tappi chiusura per PROF88N/89N + PLEX89N

Set of 2 pieces of end caps, for PROF88N/89N + PLEX89N

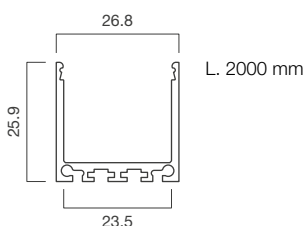

Esempio codici ordine / Example order codes

Codice profilo / Profile code

Codice diffusore / Diffuser code

Codice accessori / Accessories code

PROF88N

+

PLEX89N

+

TP8889N

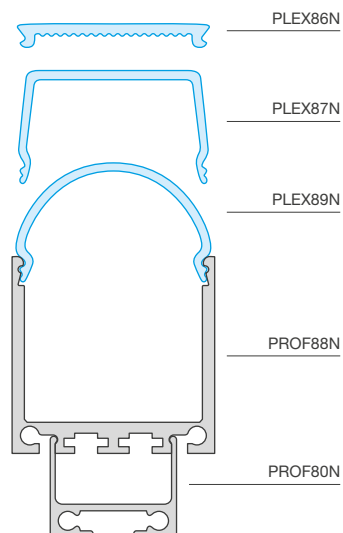

Code PROF80N
 Profilo in alluminio
 anodizzato universale
*Universal anodized
 aluminum profile*
 L. 2000 mm

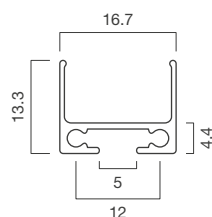

Code CL80N
 Kit 4 clip montaggio per PROF80N
*Mounting kit for PROF80N composed
 by 4 clips*

Code CAV80N
 Kit 2 cavi acciaio sospensione
 per PROF80N
*Suspension kit for PROF80N composed
 by 2 steel wires*

Code CL80S
 Kit supporti orientabili per PROF80N
Kit of adjustable support for PROF80N profile



Esempio codici ordine con accessori opzionali / *Example order codes with optional accessories*

Codice profilo / *Profile code* Codice diffusore / *Diffuser code* Codice accessori / *Accessories code*

PROF88N + PROF80N + **PLEX89N** + **TP8889N + CL80S**

PROF89N



Profilo in alluminio anodizzato per installazioni ad incasso a soffitto, per ottenere effetto di guida luminosa continua a scomparsa. La profondità del profilo permette l'omogeneità dell'emissione della luce, senza far notare i punti luminosi dei LED. L'effetto è ancora maggiore con l'impiego del diffusore rettangolare oppure bombato. Le dimensioni del prodotto permettono l'installazione fino a 2 Strip LED da 14,4W/m max cad. Disponibili tappi di chiusura in abbinamento alle diverse forme di diffusori. Abbinando il profilo universale PROF80N e gli accessori relativi, si ha la possibilità di ottenere un profilo con passaggio cavi, per il quale sono disponibili il kit per montaggio a parete o soffitto, kit per sospensione o trasformare il profilo in barra luminosa orientabile.

Anodized aluminum profile for wall or ceiling installation. The depth of the profile allows the homogeneity emission of the light, without noticing the LED light points. The effect is even greater with the use of the rectangular or convex cover profiles. The product dimensions allow up to 2x14,4W/m max Strip LEDs. End caps are available in combination with the different cover profiles. By combining the universal profile item code PROF80N and its accessories, you have the option of obtaining a cable passage profile for which you can have kits for mounting at wall or ceiling, suspension kit or transform the profile in adjustable light bar.

Finitura profilo / Profile finishing



Grigio argento
Silver gray

Code PLEX86N

Diffusore in policarbonato opale

Opal diffuser in polycarbonate

L. 2000 mm

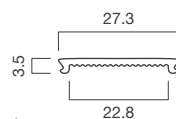

Code TP8886N

Kit 2 tappi chiusura per PROF88N/89N + PLEX86N

Set of 2 pieces of end caps, for PROF88N/89N + PLEX86N

Code PLEX87N

Diffusore in policarbonato opale quadrato

Opal square diffuser in polycarbonate

L. 2000 mm

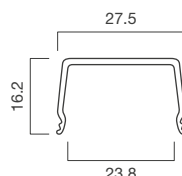

Code TP8887N

Kit 2 tappi chiusura per PROF88N/89N + PLEX87N

Set of 2 pieces of end caps, for PROF88N/89N + PLEX87N

Code PLEX89N

Diffusore in policarbonato opale bombato

Opal convex diffuser in polycarbonate

L. 2000 mm

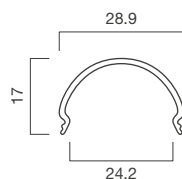

Code TP8889N

Kit 2 tappi chiusura per PROF88N/89N + PLEX89N

Set of 2 pieces of end caps, for PROF88N/89N + PLEX89N

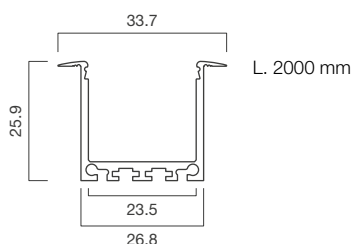

Esempio codici ordine / Example order codes

Codice profilo / Profile code

Codice diffusore / Diffuser code

Codice accessori / Accessories code

PROF89N

+

PLEX86N

+

TP8886N

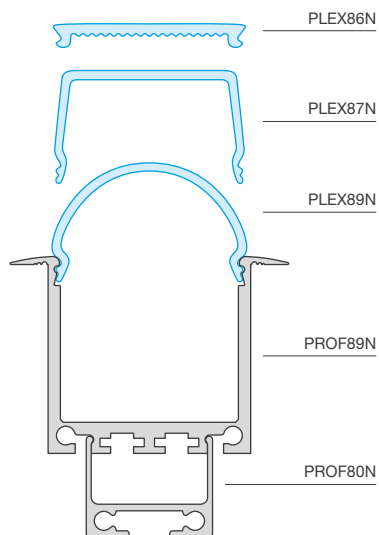

Code PROF80N
 Profilo in alluminio
 anodizzato universale
*Universal anodized
 aluminum profile*
 L. 2000 mm

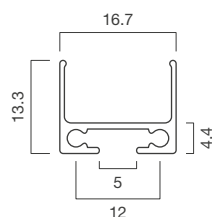

Code CL80N
 Kit 4 clip montaggio per PROF80N
*Mounting kit for PROF80N composed
 by 4 clips*

Code CAV80N
 Kit 2 cavi acciaio sospensione
 per PROF80N
*Suspension kit for PROF80N composed
 by 2 steel wires*

Code CL80S
 Kit supporti orientabili per PROF80N
Kit of adjustable support for PROF80N profile



Esempio codici ordine con accessori opzionali / *Example order codes with optional accessories*

Codice profilo / <i>Profile code</i>	Codice diffusore / <i>Diffuser code</i>	Codice accessori / <i>Accessories code</i>
PROF89N + PROF80N	+ PLEX86N	+ TP8886N + CL80N



KARMA[®]
POWERLED LIGHTING



Accessori

Alimentatori e centraline
Power supplies and controllers



Serie LRS COSTANT VOLTAGE



Code **LRS-35-12**

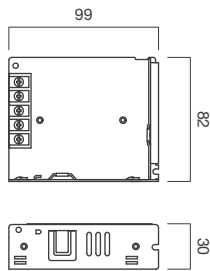

Protection	IP20
Input	85-264Vac • 47-63Hz
Output	12Vdc • 3A
Power	36W

Code **LRS-35-24**

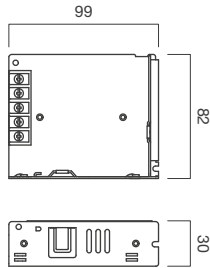

Protection	IP20
Input	85-264Vac • 47-63Hz
Output	24Vdc • 1.5A
Power	36W

Code **LRS-50-12**

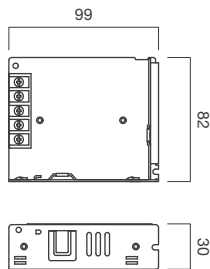

Protection	IP20
Input	85-264Vac • 47-63Hz
Output	12Vdc • 4.2A
Power	50.4W

Code **LRS-50-24**

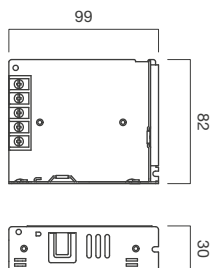

Protection	IP20
Input	85-264Vac • 47-63Hz
Output	24Vdc • 2.2A
Power	52.8W

Code **LRS-75-12**

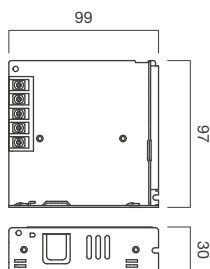

Protection	IP20
Input	85-264Vac • 47-63Hz
Output	12Vdc • 6A
Power	72W

Code **LRS-75-24**

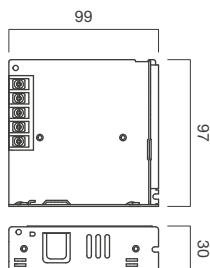

Protection	IP20
Input	85-264Vac • 47-63Hz
Output	24Vdc • 3.2A
Power	76.8W

Code **LRS-100-12**

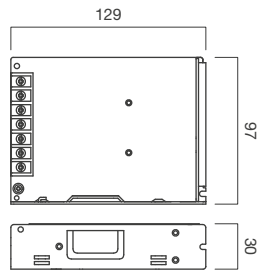

Protection	IP20
Input	85-264Vac • 47-63Hz
Output	12Vdc • 8.5A
Power	102W

Code **LRS-100-24**

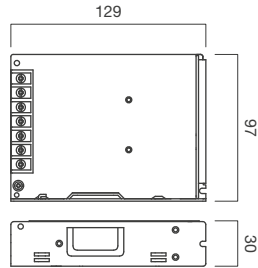

Protection	IP20
Input	85-264Vac • 47-63Hz
Output	24Vdc • 4.5A
Power	108W

Code **LRS-150-12**

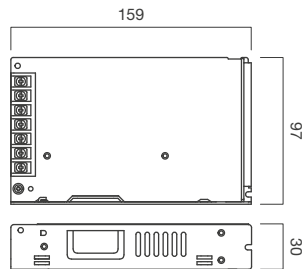

Protection	IP20
Input	85-132Vac / 170-264Vac by switch • 47-63Hz
Output	12Vdc • 12.5A
Power	150W

Code **LRS-150-24**

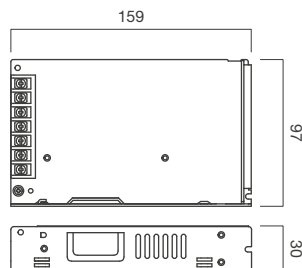

Protection	IP20
Input	85-132Vac / 170-264Vac by switch • 47-63Hz
Output	24Vdc • 6.5A
Power	156W

1. All parameters NOT specially mentioned are measured at 230Vac input, rated load and 25°C of ambient temperature.
2. Ripple and noise are measured at 20MHz of bandwidth by using a 12" twisted pair-wire terminated with a 0.1uf and 47uf parallel capacitor.
3. Tolerance: includes set up tolerance, line regulation and load regulation.
4. Line regulation is measured from low line to high line at rated load.
5. Load regulation is measured from 0% to 100% rated load.
6. Length of set up time is measured at cold first start. Turning ON/OFF the power supply very quickly may lead to increase of the set up time.
7. The ambient temperature derating of 5°C/1000m is needed for operating altitude greater than 2000m(6500ft).

8. The power supply is considered a component which will be installed into a final equipment. All the EMC tests are been executed by mounting the unit on a 360mm*360mm metal plate with 1mm of thickness. The final equipment must be re-confirmed that is still meets EMC directives. For guidance on how to perform these EMC tests, please refer to "EMI testing of component power supplies". (as available on <http://www.meanwell.com>)
9. 5V when the load factor 0~50%, the switching power less is reduced by burst operation, which will cause ripple and ripple noise to go beyond the specifications (only for LRS-35).

Serie ADT COSTANT VOLTAGE



Code **ADT030.12**

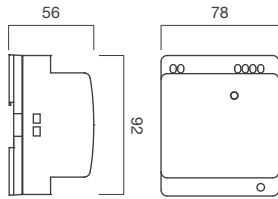

Protection	IP20
Input	88-264Vac • 50-60Hz
Output	12Vdc • 2.5A
Power	30W

Code **ADT030.24**

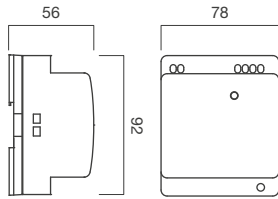

Protection	IP20
Input	88-264Vac • 50-60Hz
Output	24Vdc • 1.25A
Power	30W

Code **ADT060.12**

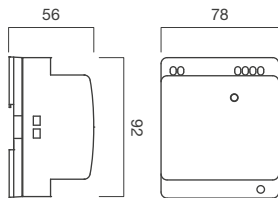

Protection	IP20
Input	88-264Vac • 50-60Hz
Output	12Vdc • 5A
Power	60W

Code **ADT060.24**

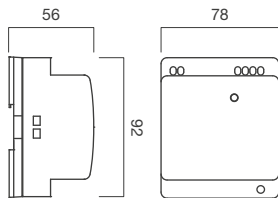

Protection	IP20
Input	88-264Vac • 50-60Hz
Output	24Vdc • 2.5A
Power	60W

Code **ADT120.12**

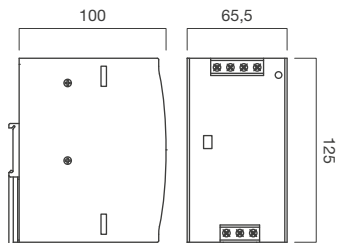

Protection	IP20
Input	88-264Vac • 50-60Hz
Output	12Vdc • 10A
Power	120W

Code **ADT120.24**

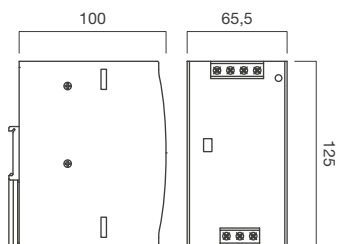

Protection	IP20
Input	88-264Vac • 50-60Hz
Output	24Vdc • 5A
Power	120W

Se non diversamente indicato, tutti i parametri sono misurati a un carico nominale in input di 230Vac e ad una temperatura ambiente di 25°C.
All parameters NOT specially mentioned are measured at 230Vac input, rated load and 25°C of ambient temperature.

Code **ALT040.12**

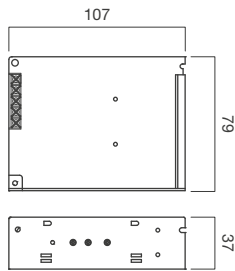

Protection	IP20
Input	100-240Vac • 50~60Hz
Output	12Vdc • 3.3A
Power	40W

Code **ALT040.24**

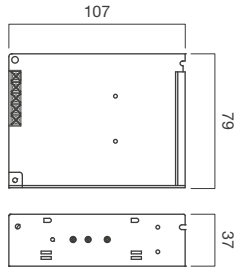

Protection	IP20
Input	100-240Vac • 50~60Hz
Output	24Vdc • 1.67A
Power	40W

Code **ALT060.12**

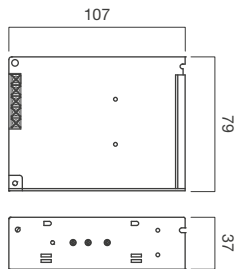

Protection	IP20
Input	100-240Vac • 50~60Hz
Output	12Vdc • 5A
Power	60W

Code **ALT060.24**

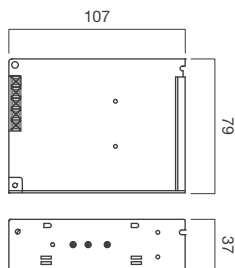

Protection	IP20
Input	100-240Vac • 50~60Hz
Output	24Vdc • 2.5A
Power	60W

Code **ALT100.12**

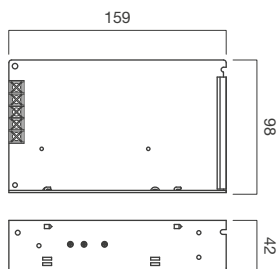

Protection	IP20
Input	100-240Vac • 50~60Hz
Output	12Vdc • 8.5A
Power	100W

Code **ALT100.24**

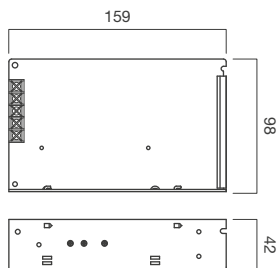

Protection	IP20
Input	100-240Vac • 50~60Hz
Output	24Vdc • 4.25A
Power	100W

Serie ALT COSTANT VOLTAGE



Code **ALT150.12**

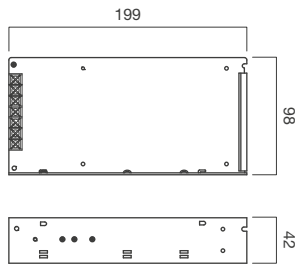

Protection	IP20
Input	100-240Vac • 50~60Hz
Output	12Vdc • 12.5A
Power	150W

Code **ALT150.24**

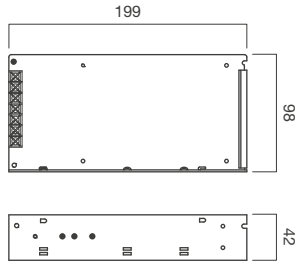

Protection	IP20
Input	100-240Vac • 50~60Hz
Output	24Vdc • 6.25A
Power	150W

Code **ALT250.12**

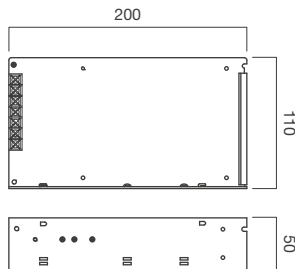

Protection	IP20
Input	100-240Vac • 50~60Hz
Output	12Vdc • 20A
Power	250W

Code **ALT250.24**

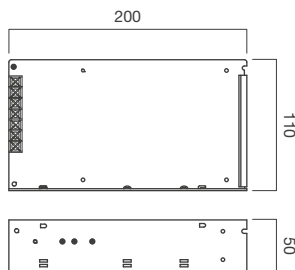

Protection	IP20
Input	100-240Vac • 50~60Hz
Output	24Vdc • 10A
Power	250W

Code **ALT350.12**

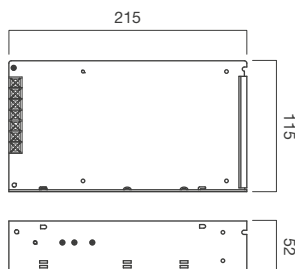

Protection	IP20
Input	100-240Vac • 50~60Hz
Output	12Vdc • 30A
Power	350W

Code **ALT350.24**

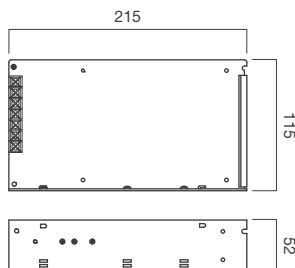

Protection	IP20
Input	100-240Vac • 50~60Hz
Output	24Vdc • 15A
Power	350W

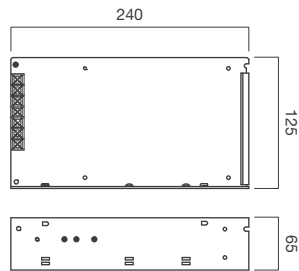
Code **ALT500.12**

Protection	IP20
Input	100-240Vac • 50~60Hz
Output	12Vdc • 41.6A
Power	500W

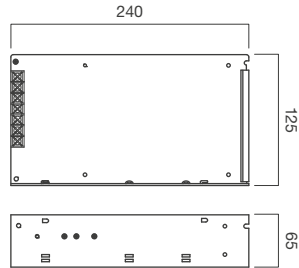
Code **ALT500.24**

Protection	IP20
Input	100-240Vac • 50~60Hz
Output	24Vdc • 20.8A
Power	500W

1. Se non diversamente indicato, tutti i parametri sono misurati a un carico nominale in input di 230Vac e ad una temperatura ambiente di 25°C.
2. Il rumore è rilevato ad una frequenza di 20MHz, usando un doppino da 12" attorcigliato terminante con un condensatore in parallelo da 0.1uf a 10uf.
3. Tolleranza: include tolleranza con regolazione del potenziometro, regolazione di linea e regolazione di carico.
4. L'alimentatore è considerato come componente che verrà installato nell'apparecchio finale. È necessario controllare che l'apparecchio finale rispetti la direttiva EMC. Per sapere come eseguire i test EMC, vi preghiamo di far riferimento ai test EMI per alimentatori.
5. Se l'alimentatore va in corto circuito senza essere sotto carico, ritornerà automaticamente in funzione non appena il corto circuito sarà rimosso (solo per ALT150W).

1. All parameters NOT specially mentioned are measured at 230Vac input, rated load and 25°C of ambient temperature.
2. Ripple and noise are measured at 20MHz of bandwidth by using a 12" twisted pair-wire terminated with a 0.1uf and 10uf parallel capacitor.
3. Tolerance: includes set up tolerance, line regulation and load regulation.
4. The power supply is considered a component which will be installed into a final equipment. The final equipment must be re-confirmed that is still meets EMC directives. For guidance on how perform these EMC tests, please refer to "EMI testing of component power supplies".
5. If the power supply is short-circuited under no load, it will recover automatically when short-circuit is removed (only for ALT150W).

Serie APT COSTANT VOLTAGE



Code **APT006.12**

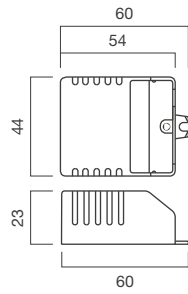

Protection	IP20
Input	100-240Vac • 50~60Hz
Output	12Vdc • Max 0.5A
Power	6W

Code **APT006.24**

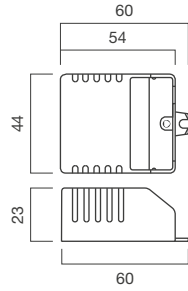

Protection	IP20
Input	100-240Vac • 50~60Hz
Output	24Vdc • Max 0.25A
Power	6W

Code **APT015.12**

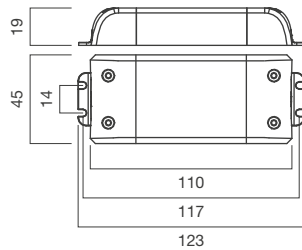

Protection	IP20
Input	220-240Vac • 50~60Hz
Output	12Vdc • 1.25A
Power	15W

Code **APT015.24**

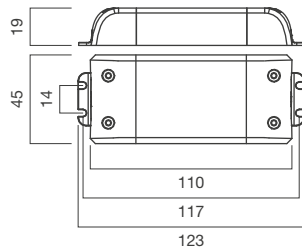

Protection	IP20
Input	220-240Vac • 50~60Hz
Output	24Vdc • 0.625A
Power	15W

Code **APT030.12**

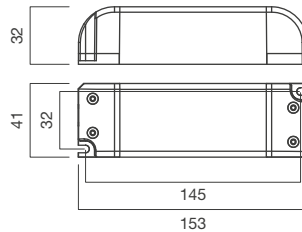

Protection	IP20
Input	220-240Vac • 50~60Hz
Output	12Vdc • 2.5A
Power	30W

Code **APT030.24**

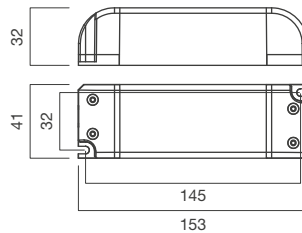

Protection	IP20
Input	220-240Vac • 50~60Hz
Output	24Vdc • 1.25A
Power	30W

Code **APT060.12**

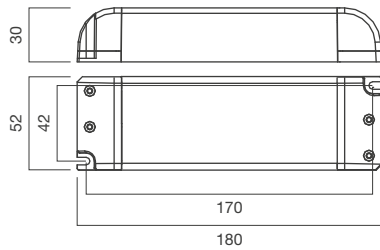

Protection	IP20
Input	220-240Vac • 50~60Hz
Output	12Vdc • 5A
Power	60W

Code **APT060.24**

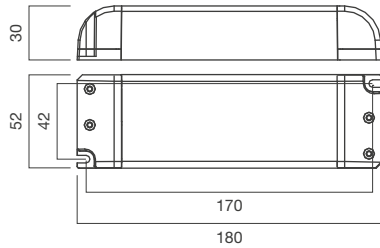

Protection	IP20
Input	220-240Vac • 50~60Hz
Output	24Vdc • 2.5A
Power	60W

Code **APT075.12**

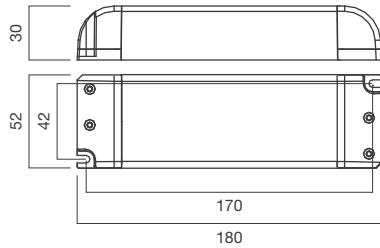

Protection	IP20
Input	220-240Vac • 50~60Hz
Output	12Vdc • 6.25A
Power	75W

Code **APT075.24**

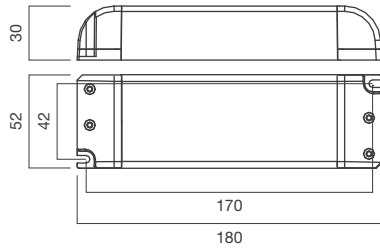

Protection	IP20
Input	220-240Vac • 50~60Hz
Output	24Vdc • 3.13A
Power	75W

Code **APT100.12**

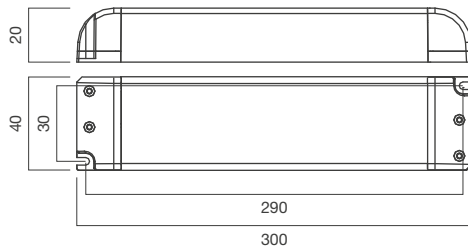

Protection	IP20
Input	220-240Vac • 50~60Hz
Output	12Vdc • 8.3A
Power	100W

Code **APT120.24**

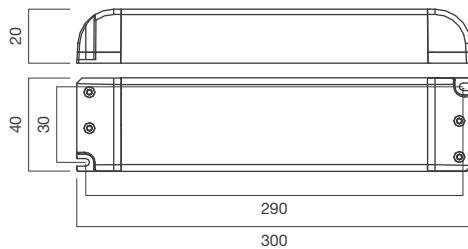

Protection	IP20
Input	220-240Vac • 50~60Hz
Output	24Vdc • 5A
Power	120W

Serie ALP COSTANT VOLTAGE



Code **ALP015.12**

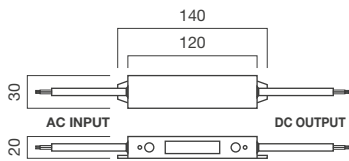

Protection	IP67
Input	90-264Vac • 50-60Hz
Output	12Vdc • 1.25A
Power	15W

Code **ALP015.24**

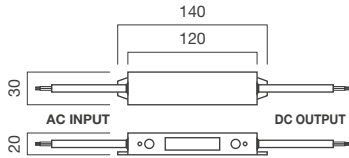

Protection	IP67
Input	90-264Vac • 50-60Hz
Output	24Vdc • 0.65A
Power	15W

Code **ALP030.12**

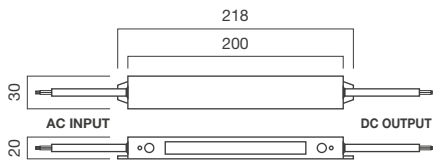

Protection	IP67
Input	90-264Vac • 50-60Hz
Output	12Vdc • 2.5A
Power	30W

Code **ALP030.24**

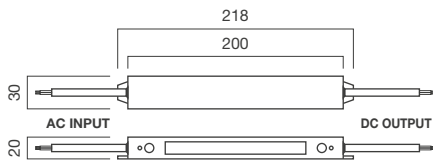

Protection	IP67
Input	90-264Vac • 50-60Hz
Output	24Vdc • 1.25A
Power	30W

Code **ALP060.12**

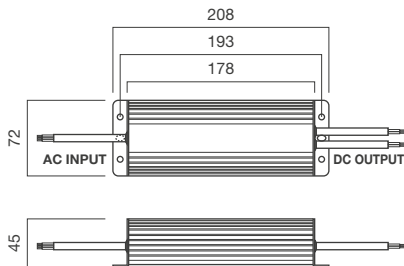

Protection	IP67
Input	90-264Vac • 50-60Hz
Output	12Vdc • 5A
Power	60W

Code **ALP060.24**

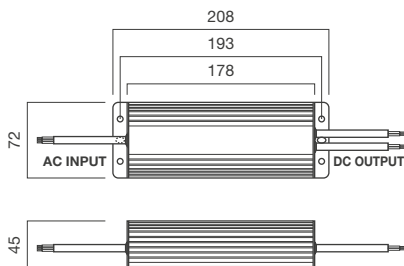

Protection	IP67
Input	90-264Vac • 50-60Hz
Output	24Vdc • 2.5A
Power	60W

Code **ALP061.12**

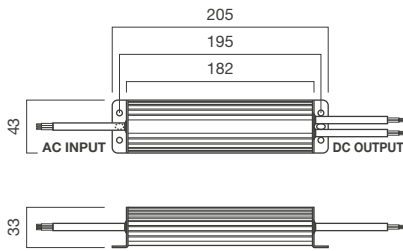

Protection	IP67
Input	100-240Vac • 50~60Hz
Output	12Vdc • 5A
Power	60W

Code **ALP061.24**

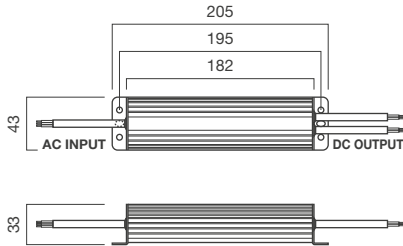

Protection	IP67
Input	100-240Vac • 50~60Hz
Output	24Vdc • 2.5A
Power	60W

Code **ALP120.12**

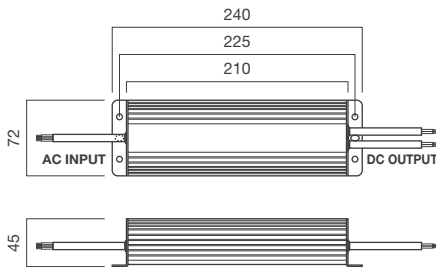

Protection	IP67
Input	170-253Vac • 50~60Hz
Output	12Vdc • 10A
Power	120W

Code **ALP120.24**

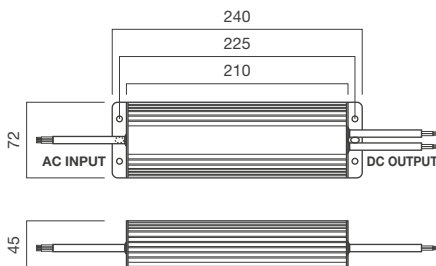

Protection	IP67
Input	170-253Vac • 50~60Hz
Output	24Vdc • 5A
Power	120W

Code **ALP150.12**

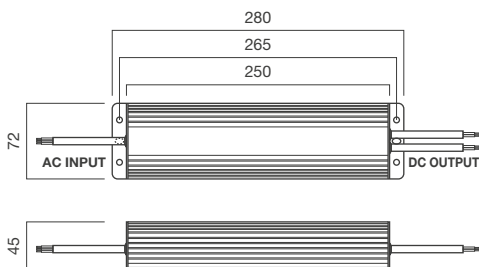

Protection	IP67
Input	170-253Vac • 50~60Hz
Output	12Vdc • 12.5A
Power	150W

Code **ALP150.24**

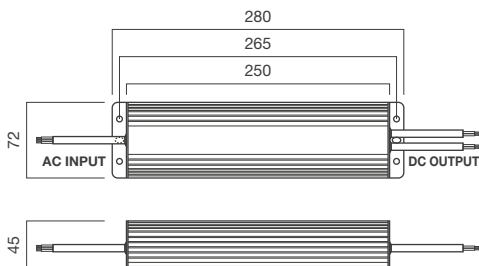

Protection	IP67
Input	170-253Vac • 50~60Hz
Output	24Vdc • 6.25A
Power	150W

Serie ALP COSTANT VOLTAGE

ECO
power

Code **ALP200.12**

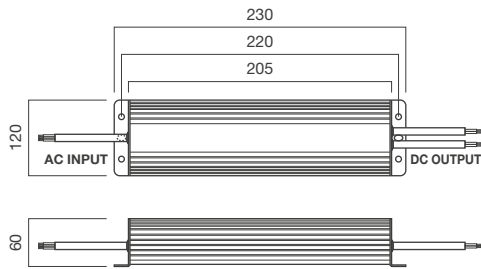

Protection **IP67**

Input **100-240Vac • 50-60Hz**

Output **12Vdc • 16.5A**

Power **200W**

Code **ALP200.24**

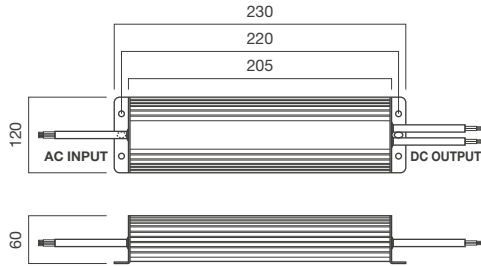

Protection **IP67**

Input **100-240Vac • 50-60Hz**

Output **24Vdc • 8.25A**

Power **200W**

1. Se non diversamente indicato, tutti i parametri sono misurati a un carico nominale in input di 230Vac e ad una temperatura ambiente di 25°C.
2. Il rumore è rilevato ad una frequenza di 20MHz, usando un doppino da 12" attorcigliato terminante con un condensatore in parallelo da 0.1uf a 10uf.
3. Tolleranza: include tolleranza con regolazione del potenziometro, regolazione di linea e regolazione di carico.

1. All parameters NOT specially mentioned are measured at 230Vac input, rated load and 25°C of ambient temperature.
2. Ripple and noise are measured at 20MHz of bandwidth by using a 12" twisted pair-wire terminated with a 0.1uf and 10uf parallel capacitor.
3. Tolerance: includes set up tolerance, line regulation and load regulation.

Code **APC006.350**

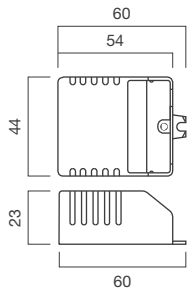

Protection	IP20
Input	100-240Vac • 50~60Hz
Output	3-22Vdc • 350mA
Number Led	1-7
Power	6W

Code **APC006.500**

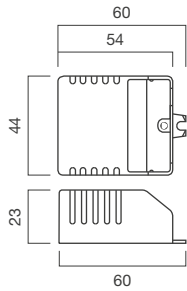

Protection	IP20
Input	100-240Vac • 50~60Hz
Output	6-14Vdc • 500mA
Number Led	2-4
Power	6W

Code **APC006.650**

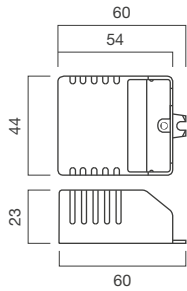

Protection	IP20
Input	100-240Vac • 50~60Hz
Output	3-12Vdc • 650mA
Number Led	1-3
Power	6W

Code **APC012.350**

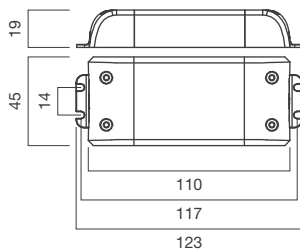

Protection	IP20
Input	220-240Vac • 50~60Hz
Output	8.4-38Vdc • 350mA
Number Led	3-10
Power	12W

Code **APC012.500**

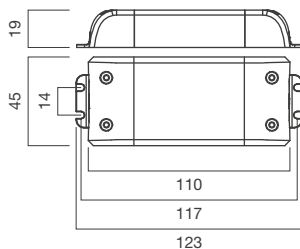

Protection	IP20
Input	220-240Vac • 50~60Hz
Output	5.5-27Vdc • 500mA
Number Led	2-7
Power	12W

Code **APC012.650**

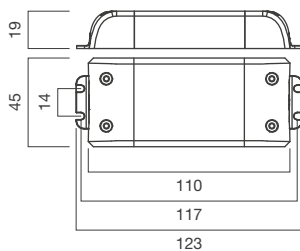

Protection	IP20
Input	220-240Vac • 50~60Hz
Output	3.5-18Vdc • 650mA
Number Led	1-4
Power	12W

Serie APC COSTANT CURRENT



Code **APC020.350**

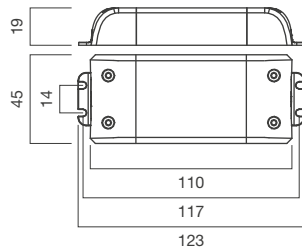

Protection	IP20
Input	220-240Vac • 50~60Hz
Output	16-57Vdc • 350mA
Number Led	6-15
Power	20W

Code **APC020.500**

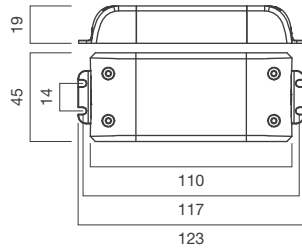

Protection	IP20
Input	220-240Vac • 50~60Hz
Output	14-40Vdc • 500mA
Number Led	4-10
Power	20W

Code **APC020.650**

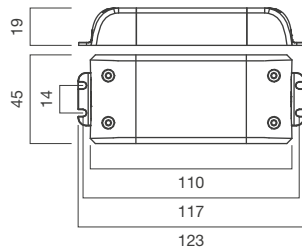

Protection	IP20
Input	220-240Vac • 50~60Hz
Output	20-34Vdc • 650mA
Number Led	3-9
Power	20W

Code **APC030.700**

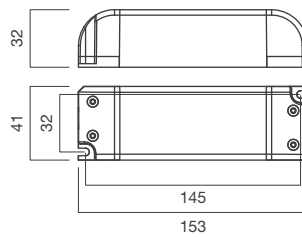

Protection	IP20
Input	220-240Vac • 50~60Hz
Output	28-43Vdc • 700mA
Number Led	8-12
Power	30W

Code **APC036.1050**

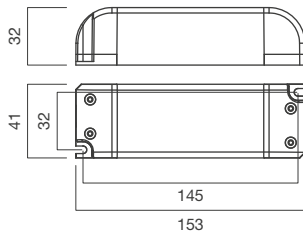

Protection	IP20
Input	220-240Vac • 50-60Hz
Output	24-35Vdc • 1050mA
Power	36W

Code **APC050.1050**

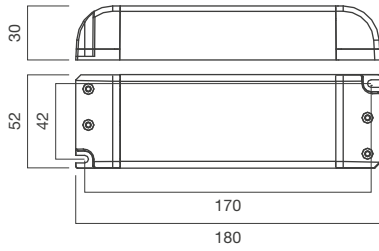

Protection	IP20
Input	220-240Vac • 50-60Hz
Output	32-48Vdc • 1050mA
Power	50W

Code **APC050.1400**

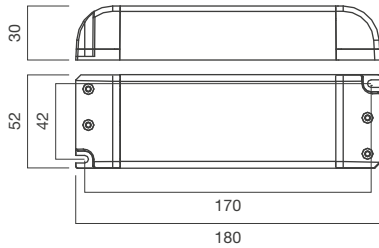

Protection	IP20
Input	220-240Vac • 50-60Hz
Output	24-36Vdc • 1400mA
Power	50W

Code **AST015.12**

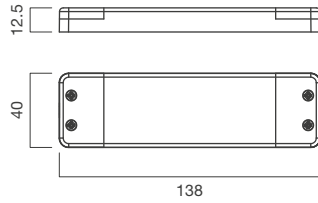

Protection	IP20
Input	220-240Vac • 50~60Hz
Output	12Vdc • 1.25A
Power	15W

Code **AST015.24**

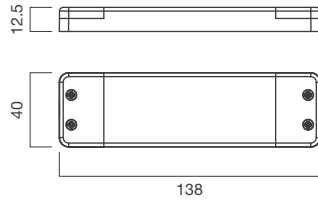

Protection	IP20
Input	220-240Vac • 50~60Hz
Output	24Vdc • 0.63A
Power	15W

Code **AST030.12**

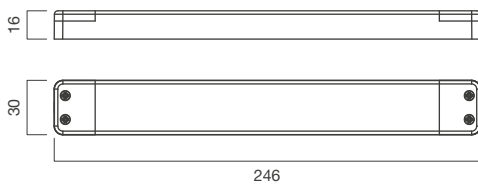

Protection	IP20
Input	220-240Vac • 50~60Hz
Output	12Vdc • 2.5A
Power	30W

Code **AST030.24**

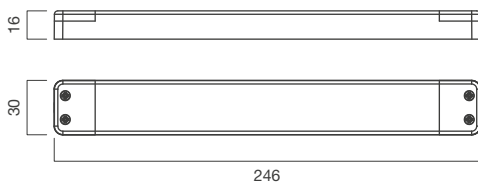

Protection	IP20
Input	220-240Vac • 50~60Hz
Output	24Vdc • 1.25A
Power	30W

Code **ACP015.500**

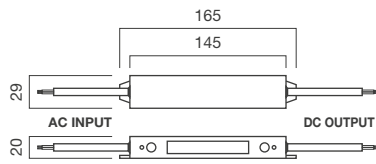

Protection	IP67
Input	170-265Vac • 47~63Hz
Output	12-30Vdc • 500mA
Number Led	4-9
Power	15W

Code **ACP018.350**

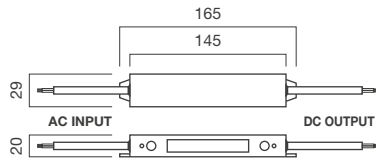

Protection	IP67
Input	170-265Vac • 47~63Hz
Output	20-50Vdc • 350mA
Number Led	7-13
Power	18W

Code **ACP032.700**

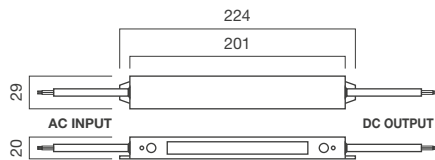

Protection	IP67
Input	170-265Vac • 47~63Hz
Output	18-45Vdc • 700mA
Number Led	6-13
Power	31.5W

Serie APP COSTANT VOLTAGE



Code **APP003.12**

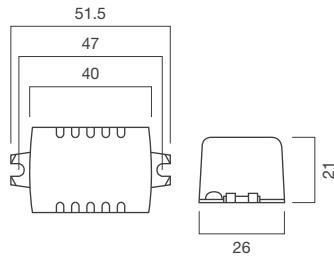

Protection	IP67
Input	100-240Vac • 50~60Hz
Output	12Vdc • Max 0.25A
Power	3W

Code **APP003.24**

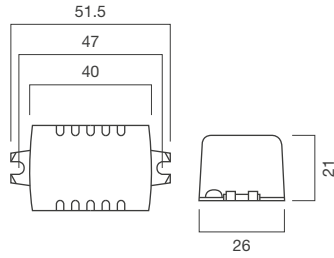

Protection	IP67
Input	100-240Vac • 50~60Hz
Output	24Vdc • Max 0.125A
Power	3W

Code **APP009.12**

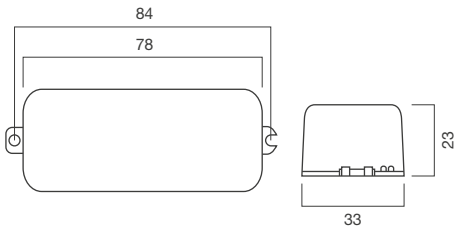

Protection	IP67
Input	100-240Vac • 50~60Hz
Output	12Vdc • Max 0.75A
Power	9W

Code **APP009.24**

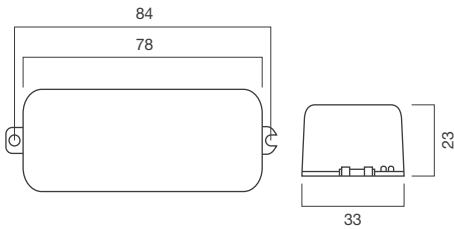

Protection	IP67
Input	100-240Vac • 50~60Hz
Output	24Vdc • Max 0.35A
Power	9W

Code **APP003.350**

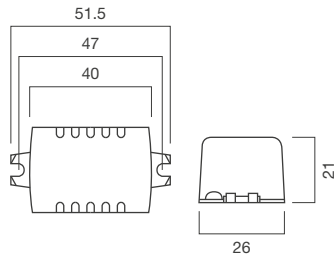

Protection	IP67
Input	100-240Vac • 50~60Hz
Output	3-12Vdc • 350mA
Number Led	1-3
Power	3W

Code **APP003.500**

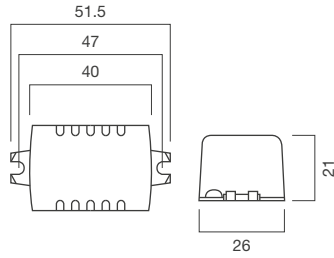

Protection	IP67
Input	100-240Vac • 50~60Hz
Output	3-7Vdc • 500mA
Number Led	1-2
Power	3W

Code **APP003.650**

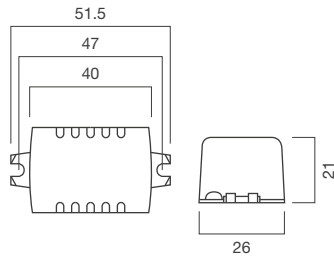

Protection	IP67
Input	100-240Vac • 50~60Hz
Output	3-5Vdc • 650mA
Number Led	1
Power	3W

Code **APP006.350**

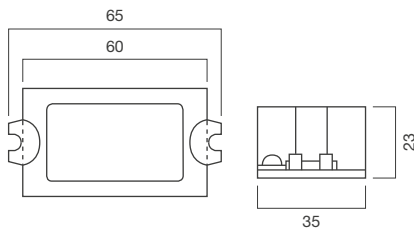

Protection	IP67
Input	100-240Vac • 50~60Hz
Output	10-21Vdc • 350mA
Number Led	3-6
Power	6W

Code **APP006.500**

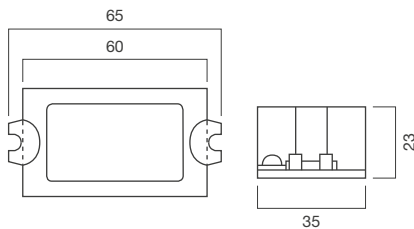

Protection	IP67
Input	100-240Vac • 50~60Hz
Output	3-12Vdc • 500mA
Number Led	1-3
Power	6W

Code **APP006.650**

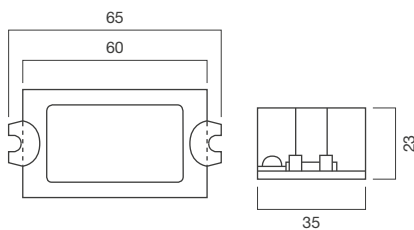

Protection	IP67
Input	100-240Vac • 50~60Hz
Output	3-10Vdc • 650mA
Number Led	1-2
Power	6W

Centralina Dimmer 1..10V.
Dimmer 1..10V controller.

Code **AL240P**

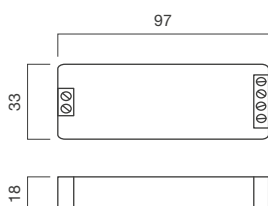

Protection	IP40
Input	12-24Vdc
Output	12-24Vdc
Controller	1..10V
Current	8A
Power	120-240W

Centralina Dimmer Dali/Push/1..10V.
Dimmer Dali/Push/1..10V controller.

Code **AL288D/P**

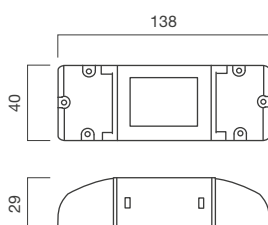

Protection	IP40
Input	12-24Vdc
Output	12-24Vdc
Controller	Dali/Push/1..10V
Current	12A
Power	144-288W

Alimentatore multicorrente/multitensione Dimmer 1..10V/Push.
Multicurrent/multivoltage Dimmer 1..10V/Push driver.

Code **DCJOLLY**

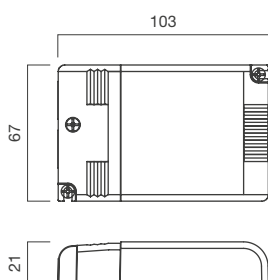

Protection	IP40
Input	110-220Vac
Output	12-24Vdc e/and 43Vdc
Controller	1..10V/Push
Current	350-500-700mA
Power	Max 25W

Alimentatore multicorrente Dimmer 1..10V/Push.
Multicurrent Dimmer 1..10V/Push driver.

Code **AL056P**

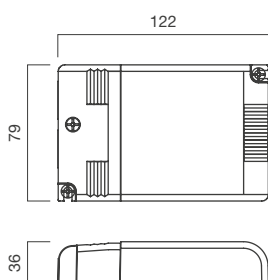

Protection	IP40
Input	100-265Vac
Output	3-48Vdc
Controller	1..10V/Push
Current	800-2000mA
Power	32-56W

ALIMENTATORI SPECIALI

ECO
power

Special drivers

Alimentatore multicorrente Dimmer Dali/Push.
Multicurrent Dimmer Dali/Push driver.

Code **AL030DALI**

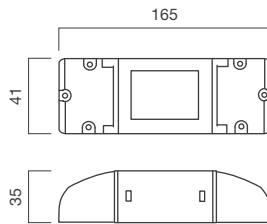

Protection	IP40
Input	100-250Vac
Output	3-42Vdc
Controller	Dali/Push
Current	250-1000mA
Power	10-30W

Alimentatore multicorrente Dimmer Dali/Push.
Multicurrent Dimmer Dali/Push driver.

Code **AL060DALI**

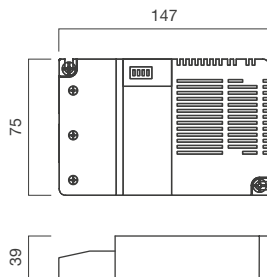

Protection	IP40
Input	100-265Vac
Output	15-48Vdc
Controller	Dali/Push
Current	700-2100mA
Power	33-60W

Kit Emergenza per LED universale, autonomia 3 ore, pacco batterie incluso.
Universal Emergency LED Kit, 3 hours autonomy, battery pack included.

Code **EMG02**

KIT EMERGENZA
EMERGENCY KIT

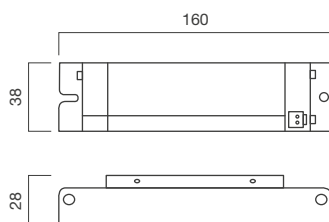

Protection	IP20
Input	220-240Vac
Output	6-60Vdc
Controller	Emergenza
Current	40-400mA
Power	30W
Battery	Ni-Cd 3.6V 3000mA/h

Sensore a infrarossi compatto, con funzione switch.
Compact infrared sensor, with switch function.

Code **S01**

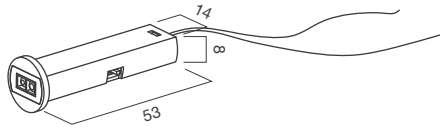

Protection	IP40
Input	12-24Vdc
Output	12-24Vdc
Controller	Switch
Current	2A
Power	24-40W

Sensore a infrarossi con centralina separata, con funzione switch.
Infrared sensor with separated controller, with switch function.

Code **S02S**

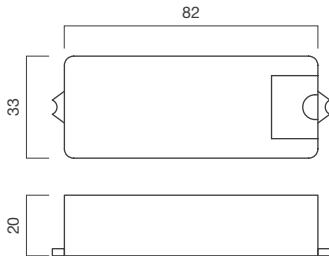

Protection	IP40
Input	12-36Vdc
Output	12-36Vdc
Controller	Switch
Current	8A
Power	96-288W

Sensore a infrarossi con centralina separata, con funzione dimmer e switch.
Infrared sensor with separated controller, with dimmer and switch function.

Code **S02D**

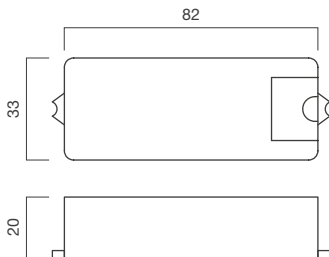

Protection	IP40
Input	12-36Vdc
Output	12-36Vdc
Controller	Dimmer & Switch
Current	8A
Power	96-288W

Sensore per profili LED a sfioramento, con funzione switch.
Touch sensor for LED profiles, with switch function.

Code **S03**

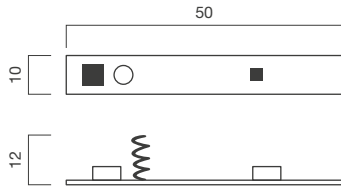

Protection	IP20
Input	12Vdc
Output	12Vdc
Controller	Switch
Current	2.5A
Power	30W

Sensore per profili LED a sfioramento, con funzione dimmer e switch.
Touch sensor for LED profiles, with dimmer and switch function.

Code **S03D**

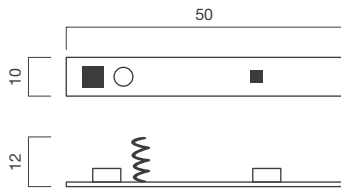

Protection	IP20
Input	12Vdc
Output	12Vdc
Controller	Dimmer & Switch
Current	2.5A
Power	30W

Centralina Dimmer PWM Push/infrarossi per contenitore 503.
PWM dimmer control unit, push/IR control, for 503 box.

Code **DIMMER1**

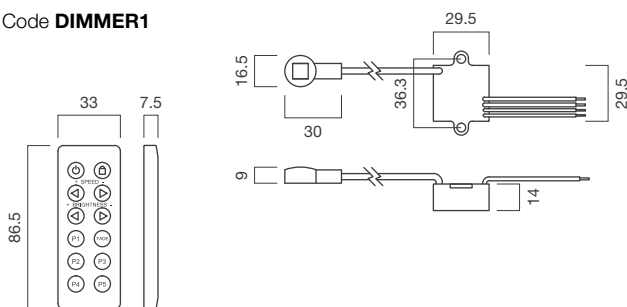

Protection	IP20
Input	12-24Vdc
Output	12-24Vdc
Controller	Comando IR/Push / IR control/Push
Current	2A
Power	25-50W
Accessories	Telecomando Infrarosso Infrared remote control

Centralina dimmer PWM con controllo WI-FI.
PWM dimmer control unit, with WI-FI controlled.

Code **DIMMER2**

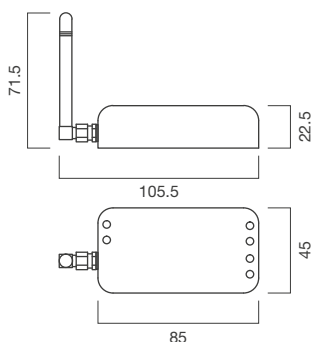

Protection	IP20
Input	12-24Vdc
Output	12-24Vdc
Controller	Interfaccia WI-FI / WI-FI interface
Current	4A x 2ch.
Power	80-160W

Centralina Dimmer con uscita 1-10V controllo Push/infrarossi per contenitore 503.
1-10V output dimmer control unit, push/IR control, for 503 box.

Code **DIMMER3**

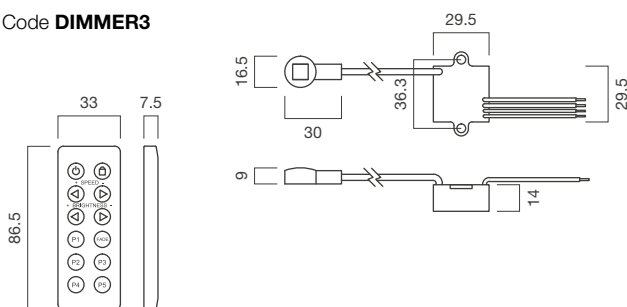

Protection	IP20
Input	12-24Vdc
Output	1-10V (Max 10 controller)
Controller	Comando IR/Push / IR control/Push
Accessories	Telecomando Infrarosso Infrared remote control

Centralina dimmer PWM a 4 zone con controllo infrarosso. Uscita DMX.
4 areas PWM dimmer control unit with IR control. DMX output.

Code **DIMMER4**

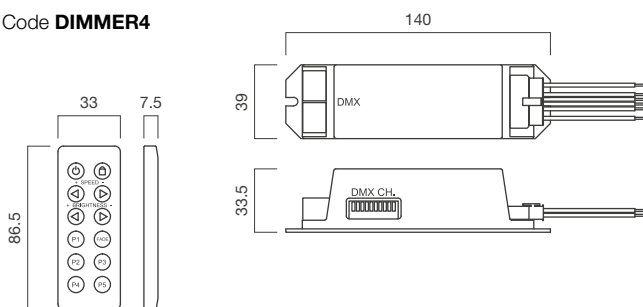

Protection	IP20
Input	12-24Vdc
Output	12-24Vdc
Controller	Comando IR/Push / IR control/Push
Current	3A x 4ch.
Power	108-216W
Accessories	Telecomando Infrarosso Infrared remote control

Compatibile con RIP-DIMMERO2N / Compatible with RIP-DIMMERO2N

Ripetitore di potenza per DIMMER4, con controllo DMX.
Power repeater for DIMMER4, with DMX control.

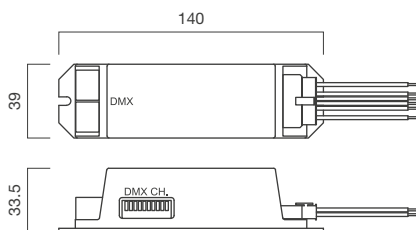
Code **RIP-DIMMER02N**

Protection	IP20
Input	12-24Vdc
Output	12-24Vdc
Controller	DMX
Current	3A x 4ch.
Power	108-216W

Compatibile con DIMMER4 / Compatible with DIMMER4

Dimmer a pannello touchscreen con uscita radio per scatola 503/504.
Touch panel dimmer with RF output for 503/504 box.

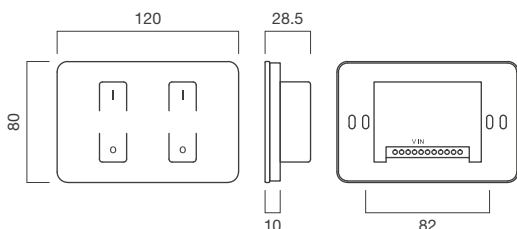
Code **DIMMER5**

Protection	IP40
Input	230Vac
Controller	RF 434-868Mhz

Compatibile con CTR203 / Compatible with CTR203

Centralina RGBW uscita master DMX con stadio di potenza.
RGBW control unit with master DMX and power output.

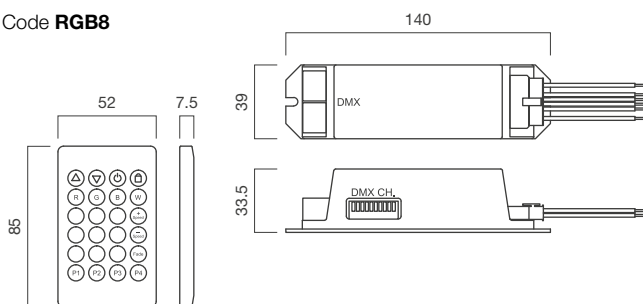
Code **RGB8**

Protection	IP20
Input	12-24Vdc
Output	12-24Vdc
Controller	Comando IR/Push / IR control/Push
Current	3A x 4ch.
Power	108-216W
Accessories	Telecomando Infrarosso Infrared remote control

Compatibile con RGB9 / Compatible with RGB9

Centralina RGBW slave DMX con stadio di potenza.
RGBW DMX slave unit with power output.

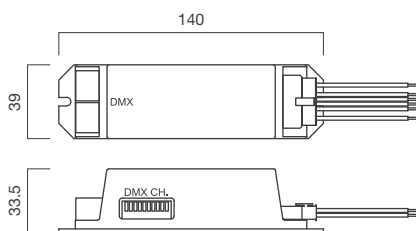
Code **RGB9**

Protection	IP20
Input	12-24Vdc
Output	12-24Vdc
Controller	
Current	3A x 4ch.
Power	108-216W

Compatibile con RGB8 / Compatible with RGB8

CENTRALINE

ECO
power

Radiocomando multifunzione RGBW a 6 zone, con scene e programmi impostabili.
6-zone RGBW multifunction radio remote control with scenes and programs selectable.



Code **RGB11N**

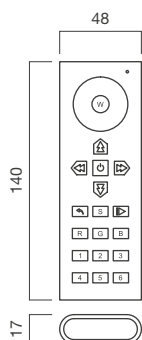

Protection	IP40
Input	3 batterie AAA / 3x AAA batteries
Controller	RF 434-868Mhz
Accessories	Supporto a muro / Wall mount bracket

Compatibile con CTR203 / *Compatible with CTR203*

Centralina multifunzione a pannello touchscreen RGBW con uscita radio per scatola 503/504.
RGBW touchscreen multifunction panel with radio output for box 503/504.



Code **RGB12N**

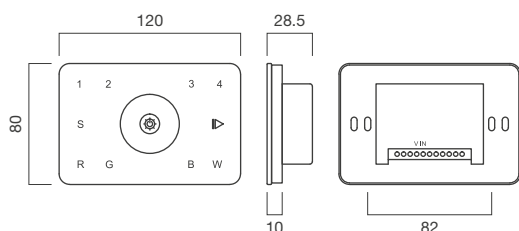

Protection	IP40
Input	230Vac
Controller	RF 434-868Mhz

Compatibile con CTR203 / *Compatible with CTR203*

Centralina RGB multifunzione con comand WI-FI.
RGB multifunction unit with comand WI-FI.



Code **RGB10**

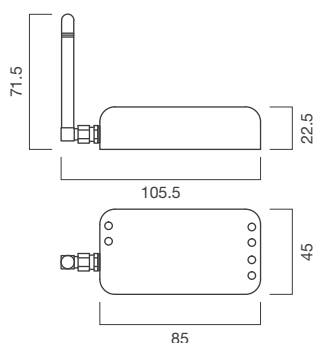

Protection	IP20
Input	12-24Vdc
Output	12-24Vdc
Controller	WI-FI
Current	4A x 4ch.
Power	120-240W

Mixer luci a 8 canali con uscita DMX.
8 channel DMX console.



Code **CX804**

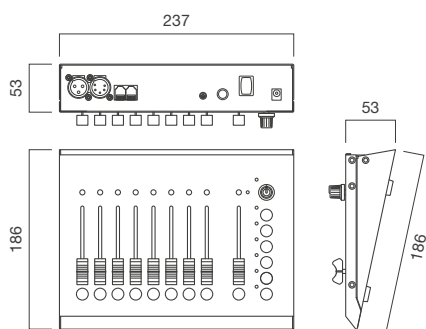

Protection	IP40
Input	12Vdc
Output	DMX
Controller	DMX 8 ch.
Input	Audio

Centralina RGBW da parete con controllo touch, adatta per scatole 503/504.
Wall touch RGBW controller compatible with box 503/504.

Code **CTR213CT**

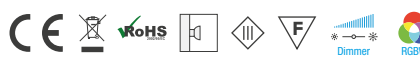
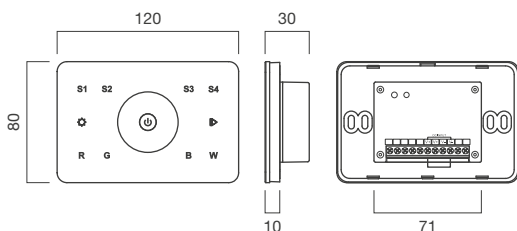

Protection	IP40
Input	12-24Vdc
Output	12-24Vdc
Controller	Touch/RF/DMX
Current	16A
Power	192-304W
Accessories	CTR213R Radiocomando RF RF radio remote control (dim. 137 x 39 x 11)
Non incluso / Not included	

Centralina RGB per controllo in tensione tramite DMX/DALI.
RGB Controller LED in tension, DMX/DALI system.

Code **CTR212**

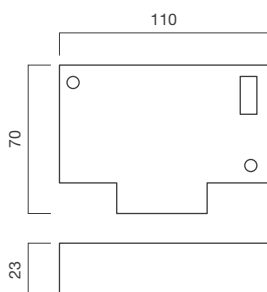

Protection	IP40
Input	230Vac
Output	24Vdc
Controller	DMX 512/Dali
Current	6A
Power	20W

Centralina RGB per controllo in corrente tramite pulsante.
RGB controller LED in current, with switch button.

Code **CTR031**

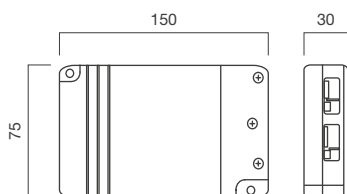

Protection	IP40
Input	100-264Vac
Output	6-33Vdc (1-9 LED)
Controller	Push
Current	350mA
Power	35W

Centralina Dimmer con radiocomando a 4 zone.
4 zone dimmer controller whit RF.

Code **CTR112DIM**

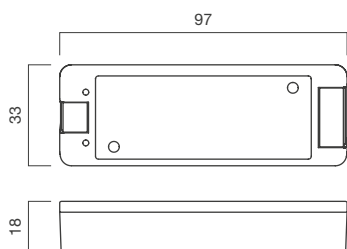

Protection	IP40
Input	12-24Vdc
Output	12-24Vdc
Controller	RF/2.4Ghz
Current	12A
Power	144-288W
Accessories	Radiocomando a 4 zone 4 zone radio remote control (dim. 107 x 58 x 7)

CENTRALINE

ECO
power

Centralina RGB con radiocomando a 4 zone.
4 zone RGB controller whit RF.

Code **CTR112RGB**

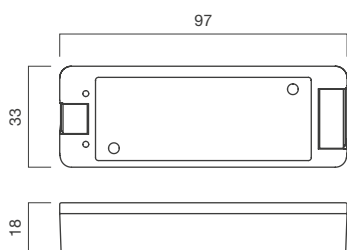

Protection	IP40
Input	12-24Vdc
Output	12-24Vdc
Controller	RF/2.4Ghz
Current	12A
Power	144-288W
Accessories	Radiocomando a 4 zone 4 zone radio remote control (dim. 107 x 58 x 7)

Centralina Bicolor con radiocomando a 4 zone.
4 zone Bicolor controller whit RF.

Code **CTR112BIC**

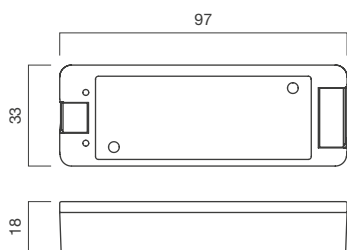

Protection	IP40
Input	12-24Vdc
Output	12-24Vdc
Controller	RF/2.4Ghz
Current	12A
Power	144-288W
Accessories	Radiocomando a 4 zone 4 zone radio remote control (dim. 107 x 58 x 7)

Amplificatore universale per qualsiasi tipo di segnale in tensione.
Universal amplifier in tension for any type of signal.

Code **AMP103**

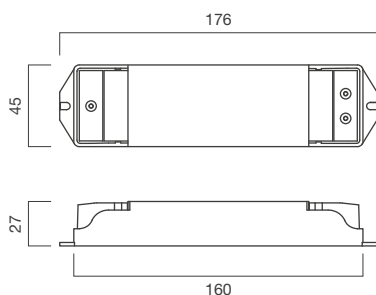

Protection	IP40
Input	12-36Vdc
Output	12-36Vdc
Controller	Amplificatore / Amplifier
Current	18A
Power	216-648W

Centralina professionale RGB per barra DIN.
Professional RGB controller DIN.

Code **CTR203DIN**

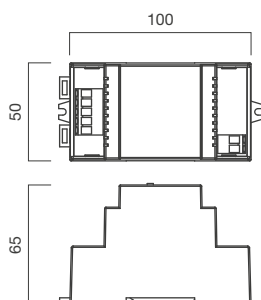

Protection	IP20
Input	12-24Vdc
Output	12-24Vdc
Controller	RF 434-868Mhz
Current	4A x 4ch.
Power	240-720W
Accessories	CTR203R Radiocomando RF a 4 zone 4 zone RF radio remote control

Centralina professionale RGB in tensione.
Professional RGB controller in tension.

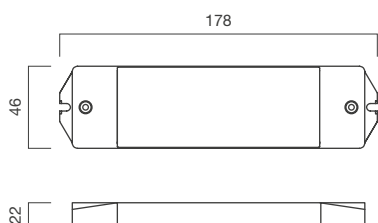
Code **CTR203CT**

Protection	IP40
Input	12-24Vdc
Output	12-24Vdc
Controller	RF 434-868Mhz
Current	4A x 4ch.
Power	240-720W
Accessories	CTR203R Radiocomando RF a 4 zone 4 zone RF radio remote control

Centralina professionale RGB in corrente.
Professional RGB controller in current.

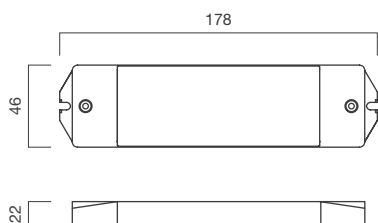
Code **CTR203C1W**

Protection	IP40
Input	12-24Vdc
Output	12-48Vdc (3-12 LED)
Controller	RF 434-868Mhz
Current	350mA
Power	17-67W
Accessories	CTR203R Radiocomando RF a 4 zone 4 zone RF radio remote control

Interfaccia RGB/DMX.
RGB/DMX interface.

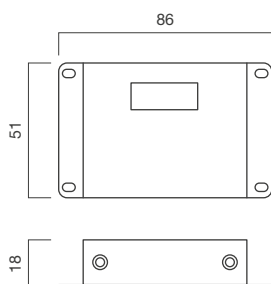
Code **CTR210**

Protection	IP40
Input	12-24Vdc
Output	12-24Vdc
Controller	Interfaccia / Interface
Current	9A
Power	108-216W

Interfaccia Dimmer/DMX.
Dimmer/DMX interface.

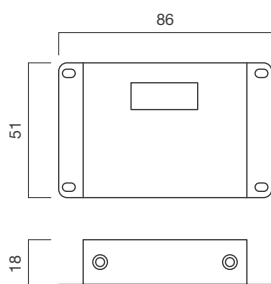
Code **CTR211**

Protection	IP40
Input	12-24Vdc
Output	12-24Vdc
Controller	Interfaccia / Interface
Current	3A
Power	36-72W

INDICE DETTAGLIATO / DETAILED INDEX

9800405005	pag.	84	B			DR02	pag.	122 - 123
9800405006	pag.	86	BOXAN12/13/35/36N	pag.	98, 101	DR05	pag.	122 - 123
9800416001	pag.	54	BOXAN14/15N	pag.	100	DR10	pag.	122 - 123
9800416017	pag.	56	BOXAN38/39W	pag.	102	DR15	pag.	122 - 123
9800500007	pag.	60	BOXAN38/39F	pag.	102	E		
9800500009	pag.	32				EMG02	pag.	215
9800500010	pag.	34, 36, 38	C			G		
9800500021	pag.	96, 106, 108 - 112	CR22N	pag.	60 - 61	GR210	pag.	74 - 79
			CTR031	pag.	221	K		
A			CTR112BIC	pag.	222	KT1001	pag.	92
ACP Serie	pag.	211	CTR112DIM	pag.	221	KT1002	pag.	92
ADT Serie	pag.	198	CTR112RGB	pag.	222	KT1003	pag.	92
AL030DALI	pag.	215	CTR203C1W	pag.	223	KT1004	pag.	92
AL056P	pag.	214	CTR203CT	pag.	223	KT1005	pag.	92
AL060DALI	pag.	215	CTR203DIN	pag.	222	KT1006	pag.	92
AL240P	pag.	214	CTR210	pag.	223	KT1011	pag.	92
AL288D/P	pag.	214	CTR211	pag.	223	KT1014	pag.	93
ALP Serie	pag.	204 - 206	CTR212	pag.	221	KT1015	pag.	93
ALT Serie	pag.	199 - 201	CTR213CT	pag.	221	KT1016	pag.	93
AMP103	pag.	222	CX804	pag.	220	KT1017	pag.	93
AN02N	pag.	96 - 97	D			KT1018	pag.	93
AN04N	pag.	96 - 97	DCJOLLY	pag.	214	KT1019	pag.	93
AN12N	pag.	98 - 99	DE02	pag.	116 - 117	KT1020	pag.	93
AN13N	pag.	98 - 99	DE12	pag.	118 - 119	KT1021	pag.	93
AN14N	pag.	100	DIMMER1	pag.	218	KT1022	pag.	93
AN15N	pag.	100	DIMMER2	pag.	218	L		
AN35N	pag.	101	DIMMER3	pag.	218	LI11N	pag.	84 - 85
AN36N	pag.	101	DIMMER4	pag.	218	LI13N	pag.	86 - 87
AN38N	pag.	102 - 103	DIMMER5	pag.	219	LRS Serie	pag.	196 - 197
AN39N	pag.	102 - 103	DO00N	pag.	64 - 65	O		
APC Serie	pag.	207 - 219	DO05N	pag.	66 - 67	OR25	pag.	54 - 55
APP Serie	pag.	212 - 213	DO06N	pag.	68 - 69	OR26	pag.	56 - 57
APT Serie	pag.	202 - 203	DO87N	pag.	134 - 135	P		
AQ24N	pag.	38 - 39	DO88N	pag.	136 - 137	PAN12	pag.	130 - 131
AQ25N	pag.	34 - 35	DO91N	pag.	138 - 139	PAN60	pag.	126 - 127
AQ26N	pag.	36 - 37	DO92N	pag.	140 - 141			
AQ35	pag.	32 - 33	DO94N	pag.	142 - 143			
AST Serie	pag.	210	DO95N	pag.	144 - 145			
			DO97N	pag.	146 - 147			
			DR01	pag.	122 - 123			

PAN69UGR	pag.	128 - 129	PLEX86N	pag.	190, 192	SC02	pag.	106 - 107
PE46	pag.	90	PLEX87N	pag.	190, 192	SC16	pag.	108
PE47	pag.	90	PLEX89N	pag.	190, 192	SC17	pag.	109
PE48	pag.	91	PROF1	pag.	152 - 153	SC18	pag.	110
PH01S	pag.	44	PROF2	pag.	154 - 155	SC19	pag.	111
PH02S	pag.	45	PROF3	pag.	156 - 157	SC20	pag.	112
PH03C	pag.	50	PROF4	pag.	158 - 159	SG01	pag.	113
PH03S	pag.	46	PROF43N	pag.	160 - 161			
PH04S	pag.	47	PROF47N	pag.	162 - 163	T		
PH05R	pag.	48	PROF48N	pag.	176 - 177	TA15	pag.	27 - 29
PH05T	pag.	51	PROF54N	pag.	164 - 165	TA151	pag.	28
PH06R	pag.	49	PROF61N	pag.	166 - 167	TA152	pag.	28
PH11C	pag.	50	PROF62N	pag.	168 - 169	TA25	pag.	19 - 25
PH11R	pag.	48	PROF63N	pag.	170 - 171	TA251	pag.	20, 22, 24
PH11S	pag.	46	PROF72BI	pag.	172	TA252	pag.	20
PH11T	pag.	51	PROF72N	pag.	172 - 173	TA31	pag.	13 - 17
PH12R	pag.	49	PROF73BI	pag.	174	TA311	pag.	14, 16
PH12S	pag.	47	PROF73N	pag.	174 - 175	TA312	pag.	14
PLEX1	pag.	152	PROF80N	pag.	178 - 179	TA35	pag.	9 - 11
PLEX5	pag.	152, 156, 158	PROF81N	pag.	180 - 181	TA351	pag.	10
PLEX21	pag.	152, 156, 158	PROF82N	pag.	182 - 183	TA352	pag.	10
PLEX22	pag.	152, 156, 158	PROF83N	pag.	184 - 185			
PLEX32	pag.	156, 158	PROF86N	pag.	186 - 187			
PLEX43N	pag.	160	PROF87N	pag.	188 - 189			
PLEX47N	pag.	162	PROF88N	pag.	190 - 191			
PLEX48N	pag.	176	PROF89N	pag.	192 - 193			
PLEX49N	pag.	176						
PLEX51N	pag.	156	R					
PLEX54N	pag.	164	RGB8	pag.	219			
PLEX61N	pag.	166	RGB9	pag.	219			
PLEX62N	pag.	168	RGB10	pag.	220			
PLEX63N	pag.	170	RGB11N	pag.	220			
PLEX72N	pag.	172, 174	RGB12N	pag.	220			
PLEX73N	pag.	172, 174	RIP-DIMMER02N	pag.	219			
PLEX81N	pag.	180, 182, 184, 188	S					
PLEX82N	pag.	180, 182, 184, 188	S01	pag.	216			
PLEX83N	pag.	186	S02D	pag.	216			
PLEX84N	pag.	186	S02S	pag.	216			
PLEX85N	pag.	186	S03	pag.	217			
			S03D	pag.	217			

GRAFICO APERTURA LENTI / LENSES WIDTH CHART

Lente/Lens 15°

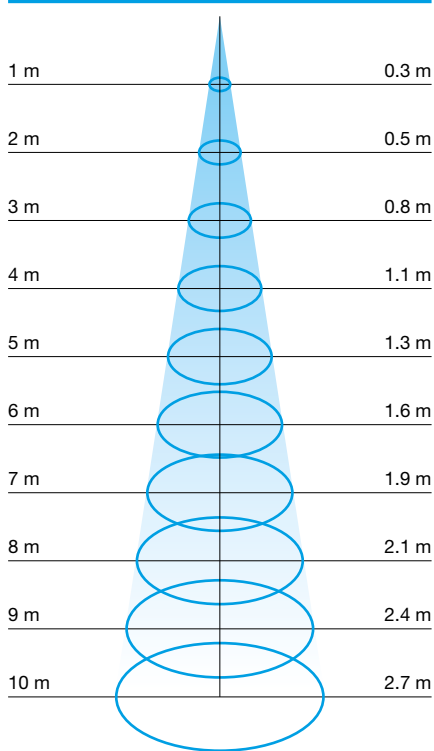

Lente/Lens 45°

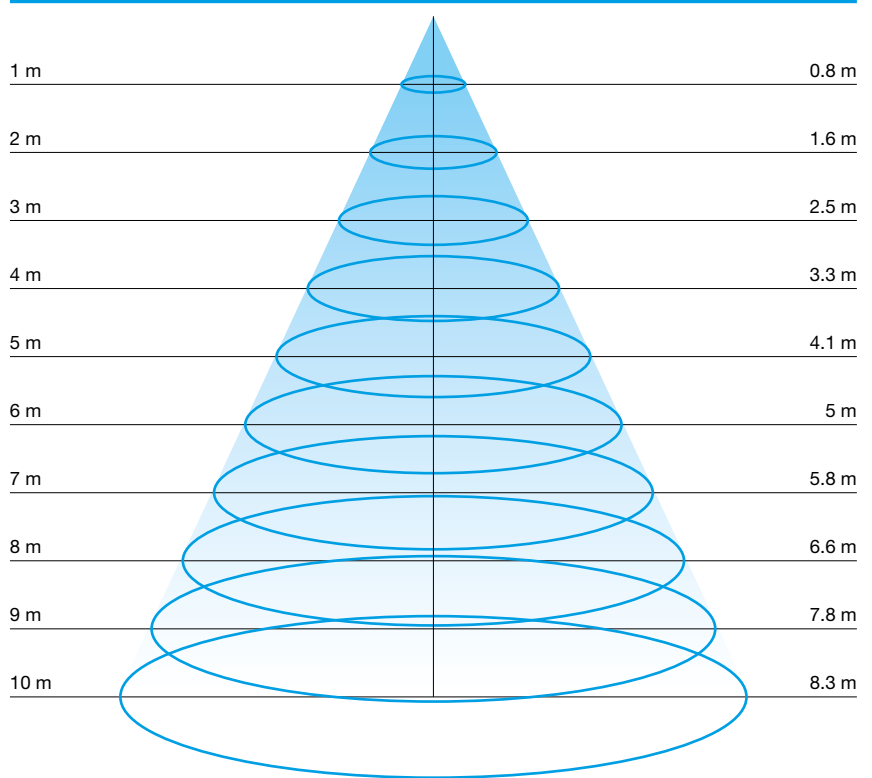

Lente/Lens 90°

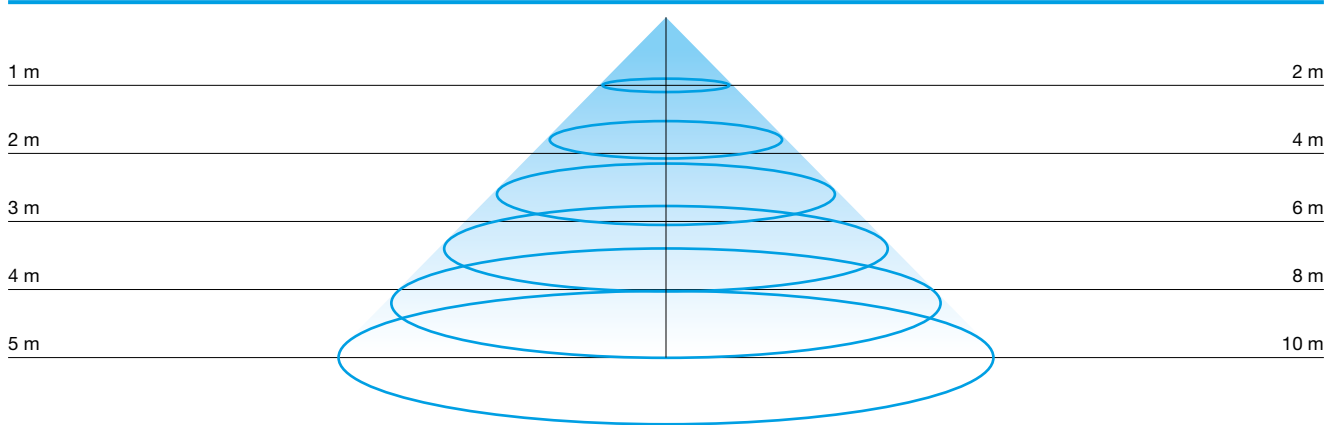

Lente/Lens 120°

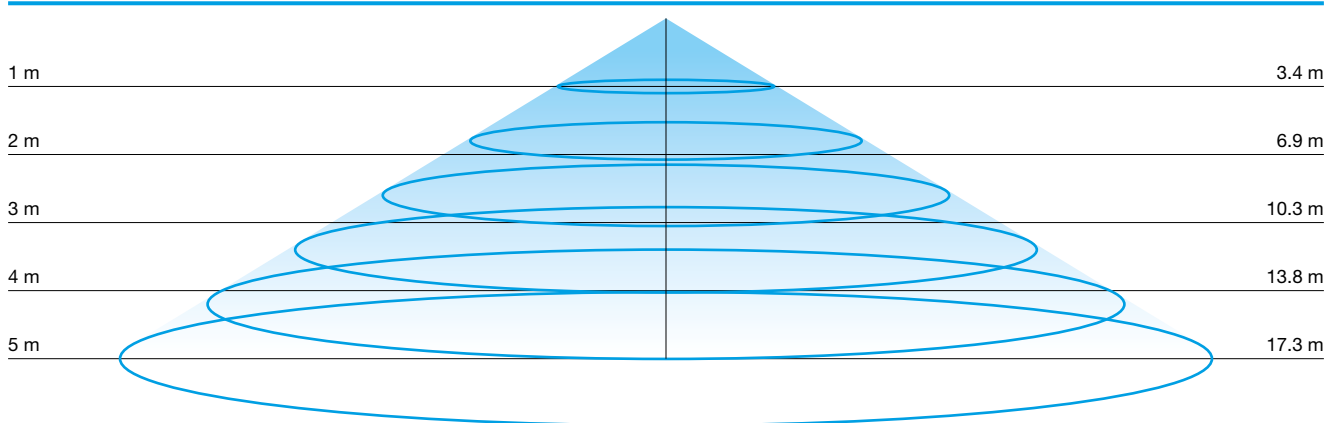

GUIDA ALLA CONSULTAZIONE / CONSULTATION GUIDE

Codice base / Base Code

MADE IN ITALY

DO00N



Legenda Led color / Led color legend



Apparecchio slim fisso da incasso per interni.
Corpo in alluminio con diffusore satinato per emissione omogenea della luce, oppure lenticolare per emissione spot.
Fissaggio tramite apposite alette metalliche, montabile su cartongesso sia a soffitto che a parete. Disponibile con varie gradazioni e colori.

Led color
1 = 3000°K (436 lumen)
2 = 6000°K (499 lumen)
3 = Blu / Blue
7 = RGB
9 = 4000°K (469 lumen)

Power supply
1 = 350mA
5 = 24Vdc

Code	DO00N
Power	3W (3 LED HP SMD)
Led color	1-2-3-9
Spot	B-D-E-T
Power supply	5
Finishing	A-D-E-F

Legenda Power supply / Power supply legend

Fixed slim recessed device for indoor.
Aluminum body, satin diffuser for homogeneous emission of light or lenticular diffuser for spot emission.
Metal mounting spring, mountable on drywall on the ceiling and on the wall.
Available in many color gradations.

Code	DO00N
Power	3W (3 LED RGB)
Led color	7
Spot	D
Power supply	1
Finishing	A-D-E-F

Legenda Spot / Spot legend



Diagramma a cono rilevato con LED HP SMD, bianco caldo, emissione 120°.
Cone diagram measured with warm white, HP SMD LED, 120° emission.

Legenda Finiture / Finishing legend

Finiture / Finishing

Bianco White	Nichel spazzolato Brushed nickel
Cromo Chrome	Ottone Brass
A	D
E	F

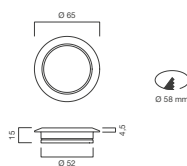
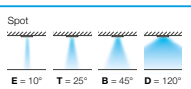
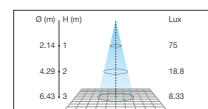

Esempio codice / Code example
DO00N3W3D5A

68 / KARMA / DORADO / DO00N

Tabella per composizione codice
Code composition table

Code	DO00N
Power	3W (3 LED HP SMD)
Led color	1-2-3-9
Spot	B-D-E-T
Power supply	5
Finishing	A-D-E-F

DO00N 3W 3 D 5 A

Esempio codice / Code example



I disegni, le dimensioni, materiali, colori e finiture presentati in questo catalogo si intendono a titolo indicativo.

Karma S.r.l. si riserva il diritto di modificare i prodotti in qualsiasi momento senza obbligo di preavviso.

I disegni e le foto sono di proprietà di Karma S.r.l.

È vietato qualsiasi tipo di riproduzione, modifica e duplicazione.

The designs, sizes, materials, colors and finishes shown in this catalog are for information purposes only.

Karma S.r.l. reserves the right to change products at any time without prior notice.

The drawings and the photos are owned by Karma S.r.l.

Any kind of reproduction, modification, duplication is forbidden.

Karma S.r.l.

Via Bachelet, 2
30037 Gardigiano di Scorzè (VE)
ITALY

Tel. +39 041 5830442

e-mail info@karmaled.it

Web www.karmaled.it





Karma S.r.l.

Via Bachelet, 2
30037 Gardigiano di Scorzè (VE)
ITALY

Tel. +39 041 5830442

e-mail info@karmaled.it

Web www.karmaled.it



SEGUICI ANCHE SU

